

# TERMITE MANAGEMENT SYSTEMS

*Edition 2 - November 2006*



**ADVISORY NOTES FOR  
HOMEOWNERS AND BUILDERS**

## **DISCLAIMER:**

The information provided in this publication is a guide only to the different systems of termite protection available.

The information provided with respect to the effectiveness and durability of the various systems referred to in this presentation may be subject to changes to the system by the manufacturer, or may vary as a result of local conditions or the manner in which the system is to be implemented.

Any person who wishes to ensure a building is adequately protected against subterranean termites should seek their own independent legal and technical advice.

The State of Queensland and Building Services Authority (BSA) shall not be liable to any person under any circumstances whatsoever, arising by virtue of a claim for breach of warranty (express or implied), tort (including negligence), strict liability or otherwise, for actual, incidental, contingent, special or consequential damages or lost profits or revenues arising directly or indirectly from or out of (but not restricted to) any claim arising out of the inaccuracy of any information contained in this publication.



## Introduction

Termite infestations cause millions of dollars in damage each year to timber in homes across Australia. Termites (white ants) are a problem in most parts of Australia, but they are particularly active in hot wet areas, such as Coastal Queensland.

The Building Code of Australia requires all new homes to have some form of management against subterranean termite attack and there are many different methods available on the market. Several changes were made to the requirements for Termite Management in Queensland on 1 January 2001. These changes included new licencing requirements and changes to the Building Code of Australia. Australian Standards 3660.1-2000, 3660.2-2000 and 3660.3-2000 are also now available.

Homeowners and contractors must realise newly built homes represent large investments, and the cheapest

method of termite management may not be the best or most appropriate method for their specific site requirements.

The primary purpose of this publication is to inform builders, trade contractors, designers, pest controllers and homeowners of the facts behind the different types of termite management systems, and to clarify responsibilities in relation to on-going maintenance requirements.

At the end of the day, homeowners must be proactive in the decision making process. And most importantly, they must ensure they arrange for appropriately licensed and qualified operators to carry out regular inspections. Also, they must ensure they do not disturb any termite management systems, otherwise their warranties and insurance entitlements could be adversely affected.

# Statutory and Licensing Requirements

## Australian Standard:

Australian Standard 3660.1-2000 Termite Management - New Buildings is referenced in the Building Code of Australia (BCA). It is part of a trilogy of standards including Part 2 that deals with existing buildings and Part 3 that deals with assessment for termite management systems. The standard was upgraded in 2000 and provides, amongst other things, for chemical barriers to extend 50mm below the top of a footing.

## Licensing

The licensing requirements for Termite Management include licence classes Termite Management - Chemical and Termite Management - Physical. The latter class is restricted to a particular physical system such as graded stone or stainless steel mesh.

These licence classes are required for the inspection or investigation of - and provision of advice or reports about - termite management systems or infestations in a completed building as well as pre-slab and perimeter treatment of sites.

It should be noted that this is in addition to the possession of a Government issued (occupational) Pest Control Operator's licence when chemicals are applied.

Professional Indemnity Insurance to a minimum value of \$500,000 is also

required, with a run-off provision which automatically operates for a period of three years.

In addition, it is important to use an Acknowledgment Form, similar to that recommended by BSA, before entering into a contract. This form confirms that the licensed contractor has counselled the consumer in the alternative termite management systems and the various cost, durability and ongoing maintenance responsibilities.

## Building Code of Australia (Queensland Provisions)

It is important to note that the BCA as it applies in Queensland, has a variation that requires:

- The ability to replenish a chemical termite management system where the life of the chemical is significantly different to that of the building. In effect this means that the hand spraying of chemicals cannot be used unless it can be proven that they will have a life span consistent with the reasonable life span of the building. If this cannot be achieved, it may be necessary for a reticulation system to be provided if chemicals are to be relied upon for termite management from below a concrete slab.
- For chemical perimeter systems the requirement is to excavate trenches,

## What does Building Law require?

treat the exposed trench with chemical, backfill with suitable material then treat the backfill. On completion to install a 300mm wide x 50mm deep concrete protection (mowing strip) layer.

- The definition of 'Primary Building Element' is extended to include door jambs, window frames and reveals and architraves and skirting in addition to structural members.
- The installation of two durable notices in prominent locations.
- The performance requirements also take into consideration accessibility for installation, maintenance and inspection of termite management systems. For example - hand sprayed chemical perimeter barriers will not be suitable for zero lot line housing.

Consideration will need to be given at the design stage for the use of termite resistant materials or some other form of termite management.



The Building Code of Australia contains the minimum technical provisions of the Queensland Building Act related to the protection of buildings from damage by subterranean termites. Any methods of termite management that can be shown to meet the performance requirements of the BCA by way of suitable documented evidence, may be accepted by the building certifier or approval authority. In Queensland the risk of primary building elements being damaged by subterranean termites must be minimised and provide for a 50 year design life.

For houses and associated sheds, carports, garages, etc, clause 3.1.3 of Volume 2 of the BCA specifies the means of satisfying the performance requirements. In the case of termite control, compliance with any of the systems (or a combination of them) detailed in Australian Standard (AS) 3660.1-2000 Protection of Buildings From Subterranean Termites - Part 1: New Buildings - satisfies clause 3.1.3. Australian Standard 3660-1.2000 specifies a range of termite management measures which may be used, including chemical or physical barriers or a combination of any of these.

*NOTE: Clause 3.1.3 must be read in conjunction with the Queensland Amendment to the BCA.*

## Regular Competent Inspections



Regardless of the system used, regular inspections should be carried out by a BSA licensed contractor with the appropriate Termite Management licence - to ensure termites have not crossed (bridged) the barrier. It is recommended that inspections be at intervals not exceeding 12 months (more frequently in high risk areas).

From the limited evidence available, it appears the majority of infestations occur at the perimeter of the building and usually result from homeowners being unfamiliar of "good practice". For example, an existing termite management system can be bridged by building garden beds or placing wood chips up to the house, or by attaching unprotected structures such as carports, pergolas, fences, etc, to the house.

### Method of Attack

Attacks on buildings are usually initiated from a nest below the ground. Termites build galleries over piers or walls to attack wood and wood products in buildings. Usually, the nest is outside the building perimeter but occasionally a nest may be buried in the soil beneath the building. Access can be gained to the inside of the building via wall cavities, cracks in mortar or concrete slabs and voids adjacent to service entry points.

# Chemical Systems



Chemical systems are normally used in conjunction with slab-on-ground construction. Traditional chemical treatments incorporate a chemical system under the slab and around the perimeter of the building.

AS3660.1 specifies the procedures to be followed to provide a chemical system which will impede termites from gaining access to the termite susceptible members in the building. Section 8 does not refer to any specific chemical, instead it will allow the use of any chemical that is registered for the purpose by The Australian Pesticide and Veterinary Medicines Authority (APVMA). This allows for the introduction of any future approved chemical.

*(Australian Pesticide and Veterinary Medicines*

*Authority (APVMA) is a Commonwealth organisation responsible for the registration of all agricultural and veterinary chemicals).*

Most chemicals used in termite management have a limited life span. It is recommended that you contact the manufacturers of products to obtain information regarding the life expectancy of these products and details of the label conditions which must be adhered to when they are being used in termite management systems.

*NOTE: If the expected life of a chemical is less than the expected life of the building, and that chemical is inaccessible, a reticulation system must be installed to allow for replenishment of those chemicals*

## Chemical Systems *continued*

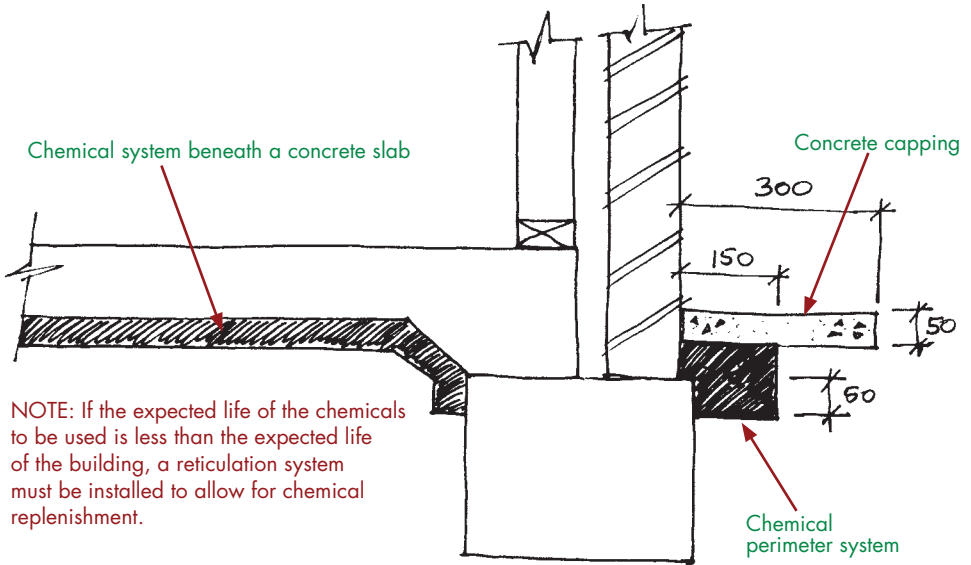

Specific Queensland provisions of the BCA will require proof to be provided that shows hand sprayed chemicals under concrete slabs have a reasonable life span before they can be used.

If, during the regular competent inspection of the building termite infestation is discovered, re-treatment may be necessary to remove the problem and to ensure the building is given protection for a reasonable life expectancy.

A convenient means of re-treating under slabs is by the use of a reticulation system. Reticulation systems need to be installed under the slab prior to pouring concrete. A reticulation system will allow periodic re-charging to be carried out from outside the building.

Before making a final decision as to what method of control is to be used, you should make yourself fully aware. Ask your builder, designer or some other competent person for details about the method of termite control being used, how it is intended to perform as a system and what your responsibilities are with regard to the on-going maintenance of the system.





# Physical Systems



Until recently, physical systems have been restricted mainly to suspended floor construction (eg houses built on stumps). The traditional physical system is the ant cap. Ant caps are used primarily on elevated houses and are placed on the tops of stumps, piers etc. Ant caps will not prevent termites from getting into the building. They will act as a barrier to encourage the termites into the open where they can be noticed when inspections are carried out.

It is important to note that the metal flashing installed in clad framed slab-on-ground construction should not be confused with traditional ant capping. A form of termite management system

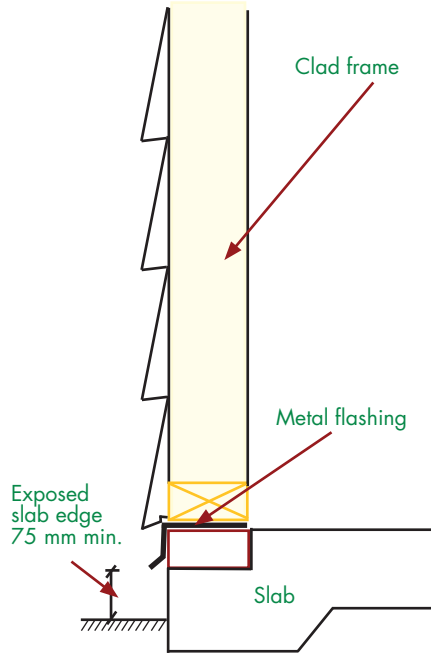

such as exposed slab edge is required in these circumstances.

A number of other physical systems are available that are suited to slab-on-ground construction. In many cases they can also be used in elevated houses.



# Graded Stone

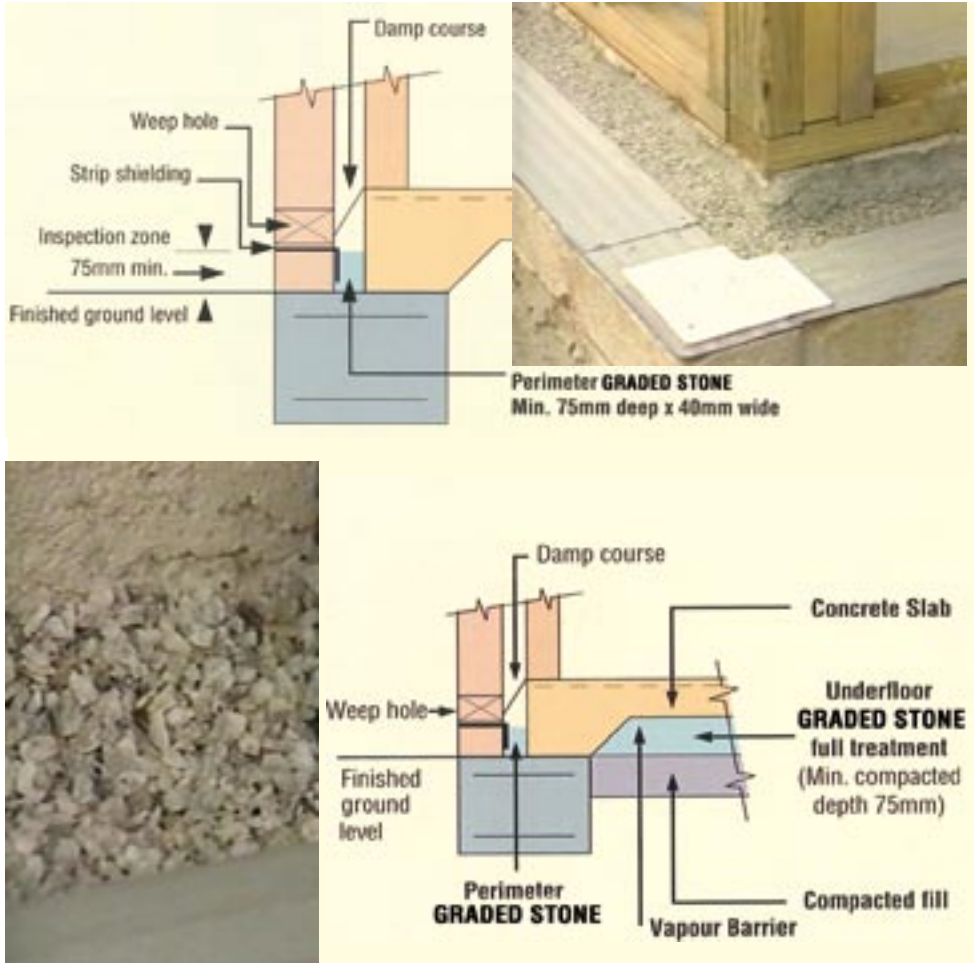

Graded stone systems incorporate carefully graded and shaped, high quality granite particles which can be placed in a layer under the entire concrete slab area, around the base of stumps in an elevated building, as a partial system around the perimeter of the building or around individual penetrations (combinations of physical and chemical systems may be

necessary in some instances). The system works on the principle that the particles, when placed and compacted, will not allow the termites to find a path through them. The particles are too hard to eat and are too small to allow the movement of termites.

# Stainless Steel Mesh

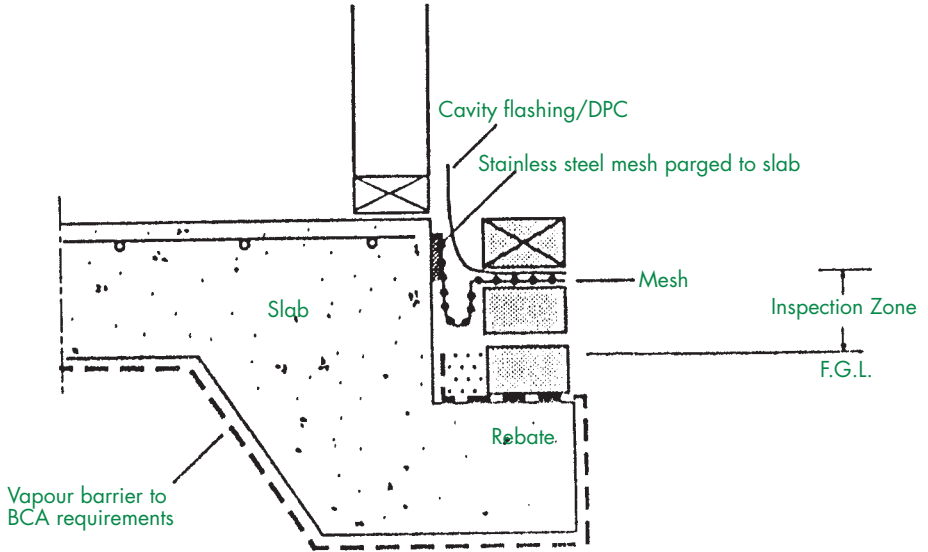

**The mesh is parged (bonded) to the side of the slab rebate, stepped down into the cavity and generally run on the second course of the outside brickwork below the flashing or dampcourse.**



Stainless steel mesh systems incorporate finely woven, high grade stainless steel mesh. This can be used in the same manner as the traditional ant cap, being placed under the entire concrete slab area, around the perimeter of the building as a partial barrier or around individual penetrations. Combinations of physical and chemical systems may be necessary in some instances.



The manufacturer promotes the product on the understanding that the grid pattern of the mesh is fine enough to not allow the termites through - and is strong enough to prevent them from chewing through it. Being stainless steel, it is unlikely to be affected by the corrosive nature of some concrete and ground conditions.

## Using a Concrete Slab as a Management System

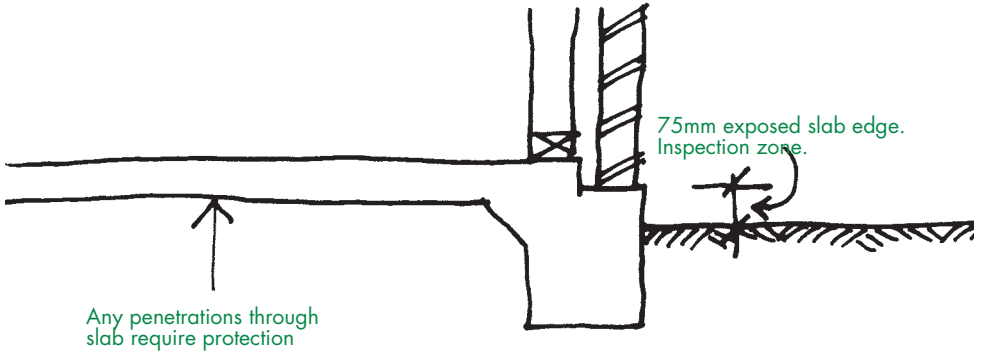

From the limited evidence available, it appears the majority of infestations occur at the perimeter of the building. Construction in accordance with Australian Standards such as AS 2870 - Residential Slabs and Footings Construction - and AS 3600 - The Concrete Structures Code, significantly reduces the likelihood of major cracking in concrete slabs, which could permit termite access.

The introduction of these Standards supports the use of the concrete slab as a termite barrier. This is reflected in 3660-1.2000.

Termite management treatment around the perimeter of a building can utilise any of the physical or chemical systems previously mentioned. One further cost-effective physical system that may be used around the perimeter of a building, utilises an exposed slab edge. The exposed slab edge won't stop the termites from gaining access into the building, but it will encourage them out into the open where they can be

noticed. Appropriate action can then be taken to destroy the nest.

Termites can still gain access via penetrations, (such as plumbing pipes), that pass through the floor and/or via the perimeter of the building. These areas require additional control using chemical or physical systems. If chemical treatment is used to protect penetrations in the concrete floor, the whole of the underslab area must be treated. If physical systems are used, only the area around the penetrations need be protected.

The BCA requires only the primary building elements of a building to be protected against damage by termites.

The definition of Primary Building Elements has been extended in Queensland to include door jambs, window frames and reveals, architraves and skirting. (This is in addition to the roof structure, loadbearing walls, beams, floor structures etc).

# Termite Resistant Materials



The BCA will allow termite resistant materials to be used to protect the termite susceptible primary building elements. Some termite resistant materials are:

## Steel

This can consist of steel floor, wall and roof framing.

## Concrete

A concrete slab on ground can itself form a termite barrier. The slab needs to be constructed as required by Australian Standards 2870 or 3600

## Timber

- Naturally termite resistant timber in accordance with Appendix C of AS 3660.1 - 2000
- Preservative treated in accordance with Appendix D of AS 3660.1 - 2000. This can consist of Light Organic Solvent Preservative (LOSP) to Hazard Level 2 or 3 (H2 and

H3). Treatments to H4 & H5 levels are required externally where timber is in contact with the ground.

This treatment can also be extended to include window reveals, door jambs, architraves and skirting.

If the use of termite resistant materials is the desired method of protection, perimeter treatment is not necessary to satisfy the BCA. The issue for prospective home and building owners to consider is 'whole of building protection'. There are a number of options to consider that should be discussed in detail between the builder and the proprietor for each individual project. The site conditions, building design and consumer requirements, such as ongoing maintenance, all need to be carefully considered prior to committing a project to construction.

# Alternative Solutions



There are several products on the market that may be accepted by Building Certifiers as meeting the performance requirements of the BCA. The use of alternative solutions must be discussed with the Building Certifier prior to any works commencing. It is best done before, but no later than at the Building Approval stage.

Many building designs use construction methods that are not particularly suited to any one form of termite control, for example - split-level buildings incorporating slab-on-ground and timber stumps. The availability of a mix of alternative methods of control will enable the owner and builder to

choose the method, or combination of methods, that is most cost-effective and most suited to the building's design. Where a combination of different types of protection is proposed, it is important you discuss the details of any warranties that may apply to the particular systems being used.



# Combinations of Chemical Systems, Physical Systems and Termite Resistant Materials

## EXAMPLES OF INTEGRATION OF VARIOUS TERMITE MANAGEMENT SYSTEMS

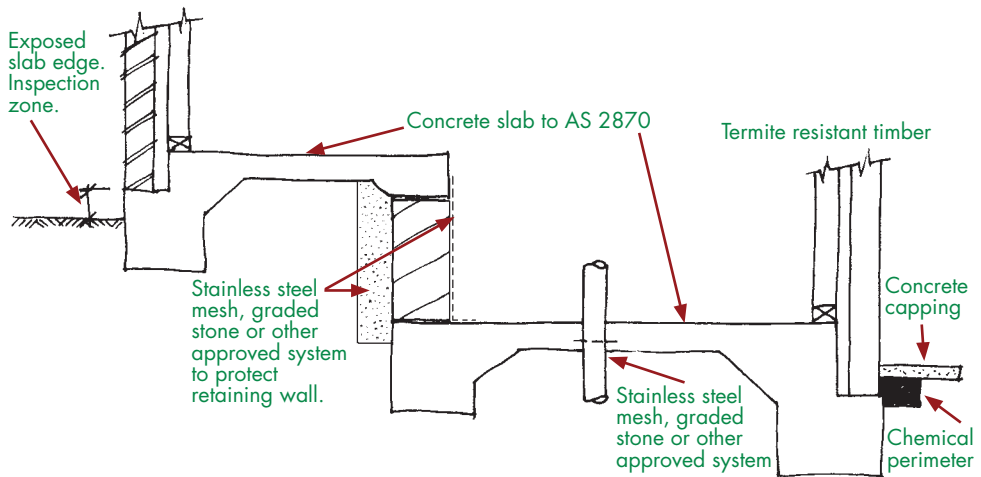

## Requirements for Suspended Floors

Some system installers may not be prepared to honour their warranties where a combination of systems is used. Split-level and zero lot line building are two examples of the need for the incorporation of physical systems or termite-resistant materials. A chemical system alone may not be suitable. Particular attention needs to be given where split level slab on ground or composite slab on ground and suspended floor framing are to be incorporated. It is likely that, as in the diagram above, a combination of systems will need to be incorporated.

Where the building has a suspended floor, cross flow ventilation must be provided under the floor. This is to discourage termite activity and to reduce the likelihood of damage to sub-floor members by fungal attack. The minimum requirement is set out in the Building Code of Australia as a net ventilation area per lineal metre of both internal and external walls. This area varies depending on the region in which the works are being undertaken. Openings must be placed below damp proof courses but above the level of possible entry of surface water.

# Minimum clearance below suspended floor

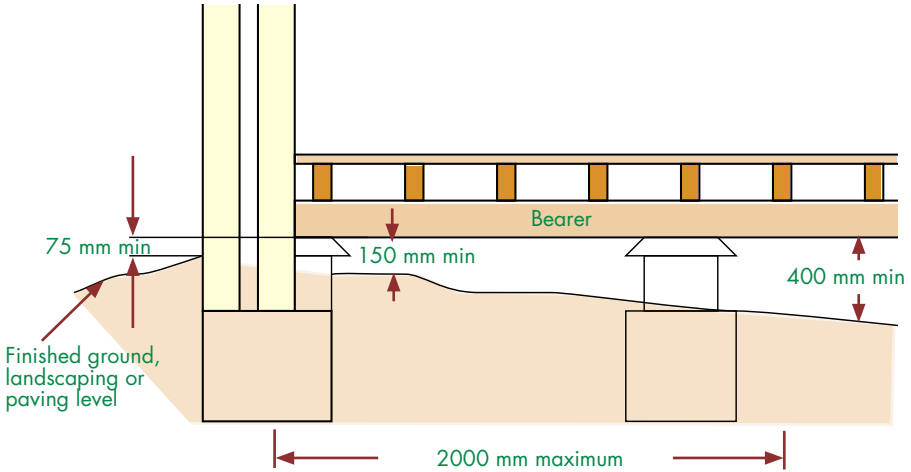

The area beneath a suspended floor is one of the most susceptible areas of a building to termite activity. To be effective, termite management systems installed in this area rely totally on access for both inspection and post treatment if termite activity is detected. To ensure access is always available to the sub-floor area, an access door or panel must also be provided. AS 3660-1:2000 contains specific provisions relevant to sub-floor clearance under suspended floors to allow for visual inspections.

A minimum clearance of 400mm is generally necessary between the finished ground level, structural components and any other obstruction ( bearers, floor joists, plumbing pipes etc). The required clearance can be reduced from 400 mm to 150 mm provided the area slopes to and is not more than 2 metres from a point conforming with the required 400 mm minimum clearance.

## Selecting a System

All of the methods discussed are considered to be reasonable options when used in conjunction with regular, competent inspections. Some methods of control are more costly than others and some methods are effective for longer periods of time than others. It is recommended that cost and lifespan comparisons be made. You should also check details of any warranties being offered with the various systems





before deciding the method of control to be adopted. BSA recommends an acknowledgement notice be utilised prior to signing a building contract. The notice confirms that the issue of termite management has been discussed in detail between the builder and consumer prior to signing a contract. It details the termite management system to be incorporated into the works and acknowledges that alternative systems have been discussed between builder and consumer.

An acknowledgement form is available for download from BSA's website at [www.bsa.qld.gov.au/Products and Services/Termite Protection System Acknowledgement Form](http://www.bsa.qld.gov.au/Products and Services/Termite Protection System Acknowledgement Form).

Building Associations and other organisations may also provide some form of acknowledgement recording for this purpose.



### **Submitting a Building Application**

The method of termite control must be detailed on the drawings

and specifications accompanying building applications. Check with your approving authority or private certifier to determine what systems are approved.

For approved systems that utilise stainless steel mesh, granite particles or reticulation systems, the system name is acceptable. Where construction techniques - for example exposed slab edge - or termite resistant materials are to be used, specific details are required.

### **During Construction**

The approving authority (Private Certifier) may require certification from the licensed installer (for the appropriate system) certifying the system has been installed in accordance with AS 3660-1.2000 (refer to AS 3660-1.2000 for details of certification requirements) and, where an "accredited" product has been used, that the system has been installed in accordance with the conditions attached to the Accreditation Certificate.

Where building certain construction techniques/practices are used, the building contractor may be required to provide documentary evidence (ie timber treatment certification, timber species identification by the supplier and the like) to certify that the building has been constructed in accordance with the requirements of AS 3660.1

The certificate should contain the following information:

- Date
- Owners name
- Builders name
- Property location
- Real Property description
- Building description
- Details of termite prevention work undertaken, including a diagram where appropriate
- Areas (m<sup>2</sup>) of the procedures for termite management which may be due to the design of the building or requirements of the owner.

### Site Practices

Trade contractors need to pay particular attention when working in and around new and existing buildings where there is the potential risk of compromising termite management systems.

It is essential to know the type of termite management system that has been utilised and its current status. If there is any ambiguity, clarification should be obtained prior to undertaking any work.

For example, a concreter may need to treat beneath a concrete slab on ground where that slab abuts a building. This can include driveways, carport slabs and footpaths.

A landscape contractor installing paving, concrete pathways or gardens adjacent to and abutting a building will also need to consider the way in which to manage the termite risk.

Plumbers and drainers need to pay particular attention when installing pipework connections to buildings.



The installation of concrete protection blocks over exposed pipework and at inspection points and the like can provide an easy point for concealed entry of termites unless adequate measures are taken. In the case of chemical perimeter systems, these protection blocks need to be placed in position after the system has been installed, being careful not to disturb the system.



This also applies to electrical contractors and to contractors installing any other services connected to a building.

Builders need to be vigilant in supervising this and other aspects of the building process to ensure adequate termite management systems are installed correctly and not compromised as part of the building process.

This includes the removal of any debris and mortar slag from footings prior to or as part of site cleaning and the subsequent installation of a chemical system. All formwork, set out pegs, timber profiles also need to be removed well clear of the area that will be required to form the termite management system.

Where construction is of a composite nature, such as where a split level slab on ground forms part of the building and where retaining walls form part of the structure, special consideration needs to be given to the type of termite management to be adopted. It may be

that a chemical system alone will not prove adequate.

It should be remembered that where chemical termite management is to be relied upon, the optimum soil type to receive the chemical is a sandy loam. The use of crusher dust or stone and rubble is not appropriate.

Termite management contractors need to check that the soil conditions are conducive to the establishment of an effective management system prior to applying any chemical.

### **Upon Building Completion**

At the completion of the works the builder should provide to the consumer, comprehensive information that details the termite management system installed and the owner's ongoing maintenance responsibilities. In the case of chemical systems it may be appropriate for a consumer to enter into a contract with a reputable, BSA licensed termite management contractor for the ongoing inspection and replenishment as recommended by the label on the product used to form the system. The owner may be required to provide a declaration to Council upon completion of the building, declaring they are aware of the system of termite control used on the building and subsequent constraints and maintenance provisions of such a system. The declaration should be on a form approved by Council. The declaration should describe the system used and contain details of the competent person who gave the advice

on the management system and its constraints. Generally, advice from the builder and system installer/consultant should be sought.

## Notices



The BCA requires a termite control notice to be permanently fixed to the building in a prominent location (eg the meter box). In Queensland two durable notices are required, both indicating:

- the method of protection.
- the date of installation of the termite management system.
- where a chemical system is to be used, its life expectancy as listed on the APVMA label.
- the installer's or manufacturer's recommendations for the scope and frequency of future inspections for termite activity

Future purchasers should be made aware of the termite management system used on the building. The onus is on the purchasers to make themselves

familiar with the on-going maintenance requirements of the system.

## Termite Management After Moving In

It is important for the homeowner to understand that properly installed and maintained termite management systems impede and discourage termite entry into buildings. They do not prevent termite attack.

Home owners should be told or advised how to find out what type of termite management system has been installed in their home. They should know if the management system is chemical or physical (e.g. concrete slabs, exposed slab edge, metal shielding, stainless steel mesh or graded stone), if termite resistant materials have been used - or a combination of chemical and/or physical and/or termite resistant materials. Generally, physical systems will be designed to last for the lifetime of the building.

Chemical systems, on the other hand, have a limited life and therefore require a higher degree of maintenance and replenishment. Termite protection is required from below and around the perimeter of the building.

## How to Reduce the Risks - The DOs and DO NOTs

- Proper, regular maintenance is essential to ensure that the termite management system is maintained to a standard that will minimise the opportunity for termite attack.
- The house should be inspected at least annually by a suitably qualified termite management contractor, licensed in Queensland by BSA. More frequent inspections may be required in high risk areas (e.g. where there is a great number of trees or virgin bush nearby).
- Check the contractor's licence with BSA before engaging them. In addition to these regular professional inspections owner vigilance, including occasional checks, is important. Home owners need to be careful not to compromise any termite

management system which has been installed in their home. The most frequent cause of termite infestation is where a perimeter system has been bridged or breached thus rendering it ineffective. Some common practices which may increase the risk of termite problems include:

- Placing turf, paving, concrete paths, bark and garden beds up against the house wall (such work may necessitate the re-establishment of the termite system by a licensed termite management contractor)

*NOTE: If a concrete path or a concrete driveway is placed up against a building, it may be necessary to reticulate if a chemical system is relied upon.*



- Leaving loose timber stacked up or leaning against the house
- The installation of new services involving underground connections to the house (e.g. pay TV) after the original termite protection has been applied.
- The construction of a pergola (75mm minimum clearance is recommended between the finished ground or pavement level and the bottom of the timber posts)
- Attaching fences, carports, or garages attached to the house after the termite protection has been installed (You should ensure that the soil surrounding any posts or timber members that are in contact with the ground is treated - or; build freestanding structures with a minimum 25 mm inspection zone between the structure and the house)
- Special care should be taken to protect the 'weep holes' (vertical joints between bricks close to ground level that are left open to allow any moisture to escape outside the house). 75mm minimum clearance is recommended from the bottom of any weep hole to the top of the garden bed, concrete or unit paving.



More comprehensive details on the use management methods can be found in Australian Standard 3660 - Control of Buildings From Subterranean Termites - Part 1: New Buildings.

This publication can be purchased from SIA Global. For full information visit their website at [www.siaglobal.com.au](http://www.siaglobal.com.au)



Further details on the legislative requirements applicable to termite management in buildings under construction can be obtained by contacting your local Council, a private building certifier or by writing to or contacting any organisations in the following list.

### **BSA**

11 Edmondstone Street  
South Brisbane QLD 4101  
Telephone 1300 272 272  
Facsimile 3225 2999  
PMB 84 Coorparoo DC 4151  
[www.bsa.qld.gov.au](http://www.bsa.qld.gov.au)

### **Building Codes Queensland**

Level 25 Mineral House  
41 George Street Brisbane  
Telephone 3234 1870  
[www.lgp.qld.gov.au](http://www.lgp.qld.gov.au)

### **Australian Environmental Pest Managers Association (AEPMA)**

Telephone (02) 9281 7699  
[www.aepma.com.au](http://www.aepma.com.au)

### **Timber Queensland**

Telephone 3254 1989  
[www.timberqueensland.com.au](http://www.timberqueensland.com.au)

### **Queensland Master Builders Association**

Telephone 3404 6444  
[www.masterbuilders.asn.au](http://www.masterbuilders.asn.au)

### **Housing Industry Association**

Telephone 3846 1298  
[www.buildingonline.com.au](http://www.buildingonline.com.au)

### **Department of Primary Industries**

Telephone 132523  
[www.dpi.qld.gov.au](http://www.dpi.qld.gov.au)

### **Queensland Health**

Queensland Health Building  
147-163 Charlotte Street  
Brisbane Queensland 4000  
Telephone 3234 0111  
[www.health.qld.gov.au](http://www.health.qld.gov.au)

### **Building Designers Association of Queensland**

Telephone 3889 9119  
[www.bdaq.com.au](http://www.bdaq.com.au)

### **Insurance Council of Australia**

Telephone (02) 9253 5100  
[www.ica.com.au](http://www.ica.com.au)



*Helping Queenslanders Build Better*

TELEPHONE STATEWIDE  
**1300 272 272**

**[www.bsa.qld.gov.au](http://www.bsa.qld.gov.au)**