



# REFERENCE MANUAL



[www.kordontmb.com.au](http://www.kordontmb.com.au)



**BACKED** by **BAYER**™

## Termite facts

- Australia has approximately 300 species of termite, of which about 15 are likely to cause damage to the structural timbers of houses.
- Termites are more closely related to cockroaches than ants.
- Of the three groups of termites (dampwood, drywood and subterranean), subterranean species cause by far the most damage to timber in service.
- The most common are *Coptotermes*, *Schedorhinotermes*, *Nasutitermes* and the giant northern termite *Mastotermes darwiniensis*.
- Some species of timber are resistant to termites, but none is termite-proof. In practice, any structure containing wood is exposed to possible subterranean termite invasion unless protective measures are taken.
- Termites will often damage materials they cannot digest such as plastics, rubber, metal or mortar. Primarily, this damage occurs when the indigestible items are encountered in the termites' search for food.
- Apart from a few grass-eating species which forage in the open, all termites remain within a closed system of underground galleries or covered runways that extend from the central nest to food sources above or below ground.
- The gallery system of a single colony may exploit food sources over as much as one hectare, with individual galleries extending for up to 50 metres.
- Each termite colony is divided into three castes: workers, soldiers and the reproductive or alate caste.
- The alates are the potential kings and queens of new colonies. Unlike the other two castes, they have eyes, functional reproductive systems and wings. They leave the colony in swarms from spring to early summer or late summer to autumn.
- Traces of swarming alates are among the few obvious signs of termite activity. They normally swarm at dusk and may be attracted to lights at night, and are commonly found in spider webs.



## Australia's only repellent physical termite barrier

Kordon Termite Barrier is a uniquely flexible building protection tool that provides a combined physical and chemical termite barrier – and can easily be moulded or cut and joined to fit complex design features.

Complete underslab installation of Kordon provides an impermeable moisture barrier for the entire building as well.

Developed in Australia, Kordon is backed by the global resources of Bayer Environmental Science – the world's largest environmental science business group and most innovative source of responsible pest and disease management solutions.

Over 15 years of assessment by Bayer, Kordon has achieved 100% success as a physical termite barrier. Kordon has also been tested and evaluated by the CSIRO, State Forestry Departments, State Building Authorities and experts in building design.

When correctly installed, Kordon is covered by a 10-year warranty. This manual shows all the different ways in which Kordon can be installed to ensure that the warranty is valid – and that Kordon can be expected to remain effective for over 50 years. In the next few pages you will also find a brief explanation of how Kordon works and contact details for accredited installers in all areas.







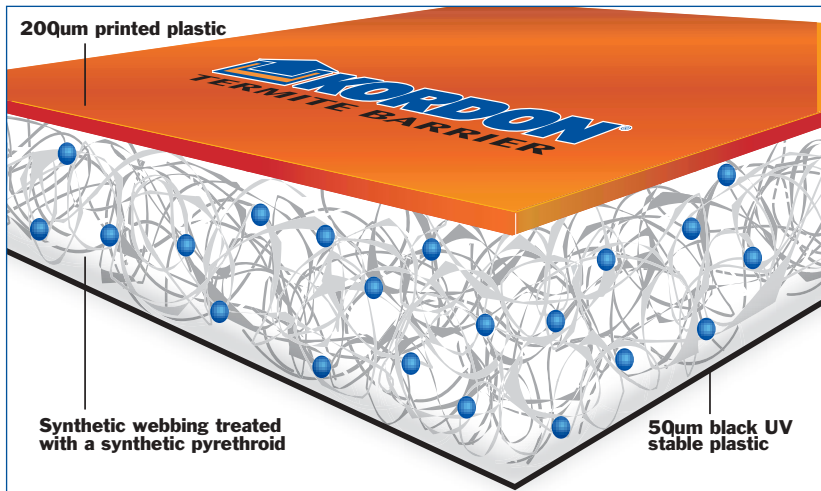
## How Kordon works

Kordon contains deltamethrin, a synthetic pyrethroid that kills termites which come into contact with it. Equally importantly, though, deltamethrin is a powerful termite repellent, so termites are very unlikely even to approach the barrier and attempt to breach it.

The deltamethrin is impregnated into a fibrous webbing which is then laminated on both sides.

The top orange 200-micron plastic layer provides the moisture vapour barrier, while the bottom black plastic layer encapsulates, protects and completes the physical termite barrier.

Kordon is classified as a building product and it is approved for use in local government areas where soil termiticide treatments have been prohibited.







## Backed by Bayer

The extensive testing of Kordon by Bayer and various independent authorities has established that the barrier should remain effective for over 50 years – the commercial life of a building.

Bayer back those findings with Kordon's 10-year \$100,000 structural timber replacement warranty against termite penetration when correctly installed by a currently accredited Kordon installer.

Once the building project is completed, Bayer and the accredited installer provide a complete set of documentation to the building owner. These documents include:

- the **Kordon 10-year Warranty**;
- a **Certificate of Compliance** to Australian Standard 3660.1-2000 and the manufacturer's specifications;
- an **Installation Report** detailing exactly where Kordon has been installed; and
- the **Annual Inspection Sticker** to record the date of regular inspections.

In addition, Kordon is certified by the Australian Building Codes Board – certification number 2003/001 – and has been tested and approved for use in 'allergen-free' construction.







## Compliance

Kordon TMB and Kordon Termite Barrier are Alternative Solutions under the Building Code of Australia, with the Assessment Method being that evidence is available that the use of Kordon TMB or Kordon Termite Barrier meets a Performance Requirement or a Deemed-to-Satisfy Provision.

Evidence of Suitability comprises reports from a Registered Testing

Authority, i.e. CSIRO, and other documentary evidence. The relevant BCA Deemed-to-Satisfy Provisions are acceptable Construction Manuals AS 3660.1-2000 *Termite Management Part 1 – New building work*. AS 3660.3-2000 *Termite Management Part 3 – Assessment criteria for Termite Management Systems* and AS 2870 *Residential slabs and footings code*.

Reference	Requirement	Evidence of suitability
AS 3660.1: C1 2.3.4	Termite resistant barrier.	ABSAC Technical Opinion 216: Kordon TMB satisfies the requirements of the BCA for protection from termites.
AS 3660.1: C1 2.3.4	Termite barrier consists of a product registered by the NRA for that purpose.	NRA Approval 48772/01: Kordon MC for application in production of Kordon TMB to protect buildings under construction from subterranean termite attack.
AS 3660.1: C1 2.2.1	Barrier system deters concealed entry.	ABSAC Technical Opinion 216 and CSIRO Appraisal 255: Installation instructions as provided by the manufacturer.
AS 2870: C1 5.3.3	Provision of a vapour barrier or a damp-proofing membrane.	ABSAC Technical Opinion 216: Kordon TMB satisfies the requirements of the BCA for damp proofing of floors on ground.
BCA vol 2, Qld variation P2. 1.1	Termite barrier to be durable.	ABSAC Technical Opinion 216 and CSIRO Appraisals Technical Assessment 255, on Durability: “These tests enable (Bayer) to claim effectiveness approaching the highly effective but environmentally unacceptable organochlorines”; “...results have been extrapolated for long time efficacy up to 50 years”.





## Suggested specification details

### Item: **TERMITE CONTROL**

KORDON TERMITE BARRIER is to be used as a Perimeter and Service Penetration system (AS 3660.1-2000)

It is to be installed by a Manufacturer's Accredited Installer, as per the Manufacturer's installation instructions.

The builder is to provide all relevant slab details to the Accredited Installer for pricing, etc.

The builder is to treat the building's termite protection as a part of the building process and therefore included in the construction program.

### Item: **TERMITE CONTROL AND MOISTURE BARRIER**

KORDON TERMITE MOISTURE BARRIER is to be used as termite protection (AS 3660.1-2000) and as a damp-proof membrane as per AS 2870.

It is to be installed by a Manufacturer's Accredited Installer as per the Manufacturer's installation instructions.

The builder is to provide all relevant slab details to the Accredited Installer for pricing, etc.

The builder is to treat the building's termite protection as a part of the building process and therefore included in the construction program.









## Accredited installers



### AUSTRALIAN CAPITAL TERRITORY

<b>ACT/NSW</b>	<b>Termi-Proof Pty Ltd</b> Ken Hill	0427 755 634
<b>ACT/NSW</b>	<b>Safeguard Termite Barriers</b> Michael Shaw	1300 855 822
<b>Canberra</b>	<b>Critter Ridder</b> Colin Wilkinson	02 6292 6471

### NEW SOUTH WALES

<b>Ballina</b>	<b>Amalgamated Pest Control</b> John Murray	02 6686 6511
<b>Ballina</b>	<b>Pestcull</b> Cliff Reynolds	02 6686 2004
<b>Ballina/Tweed Heads</b>	<b>Craig Pruul Pest Management</b> Craig Pruul	02 6680 1627
<b>Bomaderry</b>	<b>Amalgamated Pest Control</b> Mark Boyle	02 4422 8444
<b>Coffs Harbour</b>	<b>Amalgamated Pest Control</b> Robert Minogue	02 6652 4306
<b>Coffs Harbour</b>	<b>Banana Coast Pest Control</b> Graeme Hardaker	02 6653 8556
<b>Dubbo</b>	<b>PreVent Termites Pty Ltd</b> Warwick Green	02 6341 3331
<b>Grafton</b>	<b>Amalgamated Pest Control</b> Bruce Jackson	02 6644 6288
<b>Kempsey</b>	<b>Mid Coast Pest Management</b> Alec Reilly	02 6562 1515

**NEW SOUTH WALES** *(continued)*

<b>Lismore</b>	<b>Amalgamated Pest Control</b> Max Barton	02 6624 8800
<b>Lismore</b>	<b>S &amp; M Pest Control</b> Stewart Pearson	02 6682 2487
<b>Nambucca Heads</b>	<b>Amalgamated Pest Control</b> Lee Fleming	02 6568 9566
<b>Newcastle/Central Coast</b>	<b>Advanced Pest Control</b> Peter Copas	02 4962 5875
<b>Parramatta</b>	<b>Heritage Pest Control Pty Ltd</b> Dale Rigger	1300 669 990
<b>Port MacQuarie</b>	<b>Amalgamated Pest Control</b> Tony Wilcox	02 6581 3813
<b>Port Stevens/Newcastle</b>	<b>Advanced Pest Control</b> Reg Chilby	02 4982 2866
<b>Snowy Mountains</b>	<b>High Country Pest Control</b> Larry Waddell	02 6457 8217
<b>South Coast NSW</b>	<b>Proterm Termite Protection</b> Bret McManus	02 4448 5444
<b>South Coast NSW</b>	<b>Smiths Pest Control</b> Laurie Smith	02 6494 1118
<b>Sydney/NSW</b>	<b>Orange Protector Pty Ltd</b> Barry Slattery	1300 888 638
<b>Sydney/NSW</b>	<b>Safeguard Termite Barriers</b> Michael Shaw	1300 855 822
<b>Sydney</b>	<b>Alliance First</b> John Parkins	1800 886 186
<b>Sydney</b>	<b>Amalgamated Pest Control</b> Greg Moon	02 8787 1111
<b>Sydney</b>	<b>Copes Pest Control Pty Ltd</b> Mark Hopping	02 9521 3377
<b>Sydney</b>	<b>Fumapest Australia Pty Ltd</b> Michael Dubois	02 9771 2400
<b>Sydney</b>	<b>Precision Pest Control Pty Ltd</b> Peter Sakley	02 9315 5798



**NEW SOUTH WALES** *(continued)*

<b>Sydney</b>	<b>Sentinel Pest Management</b> Philip Tankard	02 9314 0259
<b>Sydney</b>	<b>Sherlock Pest Control</b> Ray Woods	02 9602 6888
<b>Sydney</b>	<b>Spectrum Pest Management</b> Kieron Ronan	1300 134 286
<b>Wagga Wagga</b>	<b>Rind Pty Ltd</b> Peter Pratt	02 6925 0198
<b>Wollongong</b>	<b>Advanced Pest Control</b> Bill Richards	02 4262 8442

**NORTHERN TERRITORY**

<b>Northern Territory</b>	<b>Quality Pest Control</b> Barry Johnson	08 8945 1194
<b>Northern Territory</b>	<b>Rapid Pest Control</b> Darren Vickers	08 8932 7977

**QUEENSLAND**

<b>Agnes Water</b>	<b>Amalgamated Pest Control</b> Grahame Elkes	07 4974 9251
<b>Airlie Beach</b>	<b>Amalgamated Pest Control</b> Michael Pipe	07 4945 3422
<b>Airlie Beach</b>	<b>Elite Maintenance Service</b> Rex Snowsill	07 4946 6881
<b>Ayr</b>	<b>Amalgamated Pest Control</b> Ross Scanlon	07 4783 4066
<b>Biloela</b>	<b>Amalgamated Pest Control</b> Steve Eather	07 4992 1007
<b>Biloela/Gladstone</b>	<b>Direct Pest Control</b> Bruce Dekker	07 4992 5799
<b>Bowen</b>	<b>Amalgamated Pest Control</b> John McElhinney	07 4786 3150
<b>Bowen</b>	<b>Pest Evict</b> Brett Skinner	07 4786 1357



**QUEENSLAND** *(continued)*

<b>Brisbane</b>	<b>Adina Professional Pest Management</b> Michael Halford	07 3351 3301
<b>Brisbane</b>	<b>Affordable Pest Control</b> Michael Flower	07 3882 2775
<b>Brisbane</b>	<b>All Purpose Pest Control</b> Warren O'Dare	07 3804 1955
<b>Brisbane</b>	<b>Alliance Industries</b> Terry Davies	07 3822 2430
<b>Brisbane</b>	<b>Amalgamated Pest Control</b> Peter Brigden	07 3373 7700
<b>Brisbane</b>	<b>Amalgamated Pest Control</b> Michael Farr	07 3277 4444
<b>Brisbane</b>	<b>Amalgamated Pre-Construction</b> Warwick London	07 3373 7788
<b>Brisbane</b>	<b>Brisbane Pre-Slab</b> Steven Slater	07 3357 7635
<b>Brisbane</b>	<b>D.K. Termite Barriers</b> David Wall	07 3297 6774
<b>Brisbane</b>	<b>East Coast Environmental Pest Control</b> Mick Bennett	07 3342 5338
<b>Brisbane</b>	<b>Eddy's Pest &amp; Weed Control</b> Edward Lewis	07 3803 4066
<b>Brisbane</b>	<b>Environmental Pest Control</b> Luke Tomkins	07 3422 2860
<b>Brisbane</b>	<b>Exzit Pest Control Pty Ltd</b> Robert Smith	07 5497 6766
<b>Brisbane</b>	<b>Hembrow's Pest Control</b> Bob Hembrow	07 3203 1928
<b>Brisbane</b>	<b>Matrix Pre-Slab Pty Ltd</b> Duane Schmid	07 3350 4909
<b>Brisbane</b>	<b>Redlands Pest Control</b> Sally Hogan	07 3390 1181



**QUEENSLAND** *(continued)*

<b>Brisbane</b>	<b>Stevie Redback Pest Control</b> Stephen Hughes	1300 665 665
<b>Brisbane</b>	<b>The Termite Man Pty Ltd</b> Iain Stephen	07 3201 2900
<b>Brisbane</b>	<b>The White Ant Man</b> Grant Currie	1300 130 338
<b>Brisbane/Gold Coast</b>	<b>Sherry's Termite Protection</b> Len File	1800 249 121
<b>Brisbane/Sunshine Coast</b>	<b>Suburban Pest Management</b> Richard Aldridge	1300 656 572
<b>Brisbane/Sunshine Coast</b>	<b>Termi-Rid</b> Bill Hendy	0417 075 080
<b>Brisbane/Russell Island</b>	<b>Auz Pty Ltd</b> Frank Devitt	07 3349 0577
<b>Bundaberg</b>	<b>Amalgamated Pest Control</b> Peter Atkinson	07 4151 5780
<b>Bundaberg</b>	<b>Suresafe Pest Management</b> Neil Lomas	07 4151 4995
<b>Bundaberg</b>	<b>Wide Bay – Burnett Pest Management</b> Stephen Barrett	07 4151 0101
<b>Caboolture</b>	<b>Amalgamated Pest Control</b> Paul McDonnell	07 4121 6040
<b>Cairns</b>	<b>Amalgamated Pest Control</b> Robert Boneham	07 4033 2875
<b>Cairns</b>	<b>Environ Enterprises F.N.Q.</b> Rodney Evans	1800 225 758
<b>Cairns</b>	<b>Natraspray</b> Rodney Evans	07 4054 2100
<b>Charters Towers</b>	<b>Amalgamated Pest Control</b> Russell Percy	07 4787 4275
<b>Emerald</b>	<b>Amalgamated Pest Control</b> David Neal	07 4982 1271
<b>Gladstone</b>	<b>Amalgamated Pest Control</b> Gavin Wharton	07 4972 4300

**QUEENSLAND** *(continued)*

<b>Gladstone</b>	<b>Amalgamated Pest Control</b> Roy Marek	07 4972 8944
<b>Gladstone</b>	<b>Natraspray</b> Michael McAullay	07 4978 2110
<b>Gold Coast &amp; North NSW</b>	<b>Capital Pest Management</b> Darrell Burgess	07 5598 6681
<b>Gold Coast</b>	<b>Amalgamated Pest Control</b> John Fleming	07 5576 1300
<b>Gold Coast</b>	<b>Bridon Spraying</b> Brian Harder	07 5545 2175
<b>Gold Coast</b>	<b>ESP Pest Control</b> John Millane	07 5579 9989
<b>Gold Coast</b>	<b>Kenny's Pest Control</b> Kenny Edwards	07 5530 8465
<b>Gold Coast</b>	<b>Pestkil Pty Ltd</b> John Lappin	0408 661 177
<b>Gold Coast</b>	<b>Termipest Termite Management</b> Luke Taylor	07 5575 6666
<b>Goondiwindi</b>	<b>Downs Pest Control</b> Kevin Devine	07 4671 1178
<b>Gympie</b>	<b>Gold City Professional Services</b> Geoff Jensen	07 5482 8244
<b>Hervey Bay</b>	<b>Amalgamated Pest Control</b> David Knowles	07 4124 4299
<b>Ingham</b>	<b>Amalgamated Pest Control</b> Ed Slater	07 4777 8077
<b>Innisfail</b>	<b>Amalgamated Pest Control</b> David Stoter	07 4061 2947
<b>Ipswich</b>	<b>Amalgamated Pest Control</b> Troy Mayes	07 3281 4533
<b>Ipswich</b>	<b>Kammand Pest Control</b> Michael Mardel	07 3818 0889
<b>Ipswich/Brisbane</b>	<b>Savco Pest &amp; Weed Control</b> Simon Savige	07 3288 8899



**QUEENSLAND** *(continued)*

<b>Kingaroy</b>	<b>Amalgamated Pest Control</b> Bradley Graham	07 4162 5030
<b>Longreach</b>	<b>Amalgamated Pest Control</b> Victor Preston	07 4658 1771
<b>Mackay</b>	<b>Amalgamated Pest Control</b> Glenn Lovett	07 4955 4466
<b>Mackay</b>	<b>Natraspray</b> Colin Easton	07 4942 6166
<b>Maleny</b>	<b>Amalgamated Pest Control</b> Raymond Farrell	07 5429 6329
<b>Mareeba/Tablelands</b>	<b>Amalgamated Pest Control</b> Darrell Turner	07 4097 6438
<b>Maryborough/Hervey Bay</b>	<b>Hervey Bay Pest Control</b> Darren Loveridge	07 4128 9141
<b>Maryborough/Hervey Bay</b>	<b>Natures Pest Management</b> Stuart Leigh	07 4124 0499
<b>Mossman</b>	<b>Douglas Shire Pest Control</b> Glenn Koch	07 4098 2801
<b>Nanango</b>	<b>Patrick Collins Pest Control</b> Patrick Collins	07 4163 2179
<b>Port Douglas</b>	<b>Amalgamated Pest Control</b> Andy Brooking	07 4098 7941
<b>Ravenshoe/Tablelands</b>	<b>Amalgamated Pest Control</b> Eddie Turner	07 4097 6438
<b>Rockhampton</b>	<b>Amalgamated Pest Control</b> Jerome Jackson	07 4921 4399
<b>Rockhampton</b>	<b>Natraspray</b> Mark Mitchell	07 4927 0712
<b>Southern Queensland</b>	<b>Bushman's Pest Control</b> Jamie Beaumont	07 4163 3275
<b>Southern Queensland</b>	<b>Pestek</b> Anthony Alexander	07 4662 5077
<b>Stanthorpe</b>	<b>Beckett's Pest Control</b> Bill Beckett	07 4681 3466

**QUEENSLAND** *(continued)*

<b>Sunshine Coast</b>	<b>Culbara Pest Control</b> Ross Beinke	07 5444 1952
<b>Sunshine Coast</b>	<b>Little Mountain Pest Control</b> Pat Lavelle	07 5494 5885
<b>Sunshine Coast</b>	<b>Pest Busters</b> Peter Hayman	07 5443 3909
<b>Sunshine Coast</b>	<b>Shorty's Pre-treat &amp; Pest Control</b> Phillip Short	07 5446 0881
<b>Sunshine Coast/Noosa</b>	<b>Termite Barrier Systems</b> Robert Read	07 5474 4448
<b>Tin Can Bay</b>	<b>Cooloola Pest Control</b> Michael Harrison	07 5468 4633
<b>Toowoomba/SE Queensland</b>	<b>Town &amp; Country Pest Control</b> David Cole	07 4636 3200
<b>Toowoomba</b>	<b>Amalgamated Pest Control</b> Royce Hodge	07 4632 7644
<b>Toowoomba</b>	<b>Savco Pest &amp; Weed Control</b> Keiran Mortimer	07 4634 7777
<b>Townsville</b>	<b>Amalgamated Pest Control</b> Ken West	07 4779 3955
<b>Townsville</b>	<b>Environ Enterprises</b> Gill Christiansen	07 4728 1610
<b>Tully</b>	<b>Amalgamated Pest Control</b> Mark Kars	07 4068 9069
<b>Warwick</b>	<b>Warwick Pest Control</b> David Cole	07 4667 0670



## SOUTH AUSTRALIA

<b>Adelaide</b>	<b>Allstate Pest Control</b> Peter Tsoutouras	08 8371 1277
<b>Adelaide</b>	<b>Complete Pest Control</b> Ross Robertson	08 8359 1511
<b>Adelaide</b>	<b>Our Earth Pest Control</b> Roger Richter	08 8234 2788
<b>Adelaide</b>	<b>Physical Termite Barriers</b> John Hoskin	08 8235 2634
<b>Barossa Valley</b>	<b>Murray Pest Control – Barossa</b> Kevin Rayner	08 8562 2822
<b>Murray Bridge</b>	<b>Terminix Pest &amp; Weed Control</b> Ashley Carter	08 8532 1493

## VICTORIA

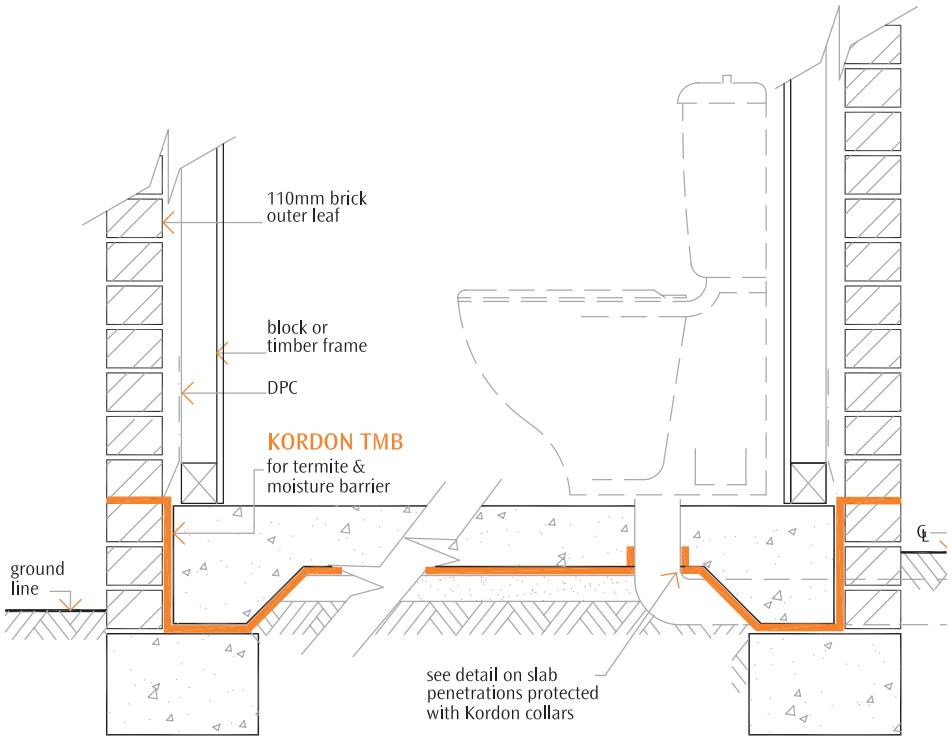
<b>Albury/Wodonga, Wangaratta &amp; Northern Victoria</b>	<b>Economic Pest Control</b> Steve Ackerly	1300 655 774
<b>Central &amp; Northern VIC</b>	<b>Ridleys Pest Control</b> David Hodgens	03 5480 2155
<b>Central &amp; Western VIC</b>	<b>Knights Pest Control</b> Leigh Knight	03 5449 6152
<b>Horsham</b>	<b>D &amp; S M Meadows</b> Daryl Meadows	03 5382 4986
<b>Melbourne</b>	<b>King-Hit Pest Control</b> Roger King	03 9852 1234
<b>Melbourne, Geelong, Central VIC</b>	<b>Natural Pest Control</b> David Odgers	03 9390 6555
<b>Melbourne, Geelong, Mornington Peninsula, Regional</b>	<b>Trimec Pty Ltd</b> Paul Harris	1800 133 393
<b>Mildura</b>	<b>Mildura &amp; District Pest Control</b> Les O'Connor	03 5024 6929
<b>Mornington Peninsula</b>	<b>Guardian Pest Control</b> Graham Pittock	03 5987 1787
<b>South East VIC</b>	<b>South Gippsland Pest Control</b> Russell Graham	03 5657 3300

## WESTERN AUSTRALIA

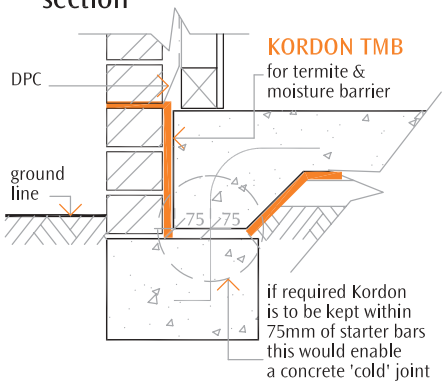
<b>Bunbury</b>	<b>Pinchs Pest &amp; Weed Control</b> Trevor Ward	08 9791 3525
<b>Bunbury</b>	<b>Western All Pest Services</b> Kelvin Knapton	08 9791 3322
<b>Derby</b>	<b>Sankey Constructions Pty Ltd</b> Allen Sankey	08 9191 2729
<b>Kalbarri</b>	<b>Kalbarri Total Pest &amp; Weed Control</b> Neville Simmonds	08 9937 1352
<b>Kalgoolie</b>	<b>Mobile Pest &amp; Weed Control</b> Julian Little	08 9093 2809
<b>Karratha</b>	<b>All – Rid Pest Management</b> John Zanik	08 9185 5553
<b>Mandurah</b>	<b>Mandurah Environmental Services &amp; Pest Management</b> Alan Price	08 9581 5806
<b>Mid Coast WA</b>	<b>Carnarvon Pest Control</b> Spencer Aylmore	08 9941 2333
<b>Mid Coast WA</b>	<b>Pest-A-Kill</b> Domenic Micono	08 9965 3330
<b>Perth</b>	<b>Advanced Pest Control</b> John Novatsis	08 9328 2678
<b>Perth</b>	<b>Champion Pest Control</b> John Papanaoim	08 9444 0550
<b>Perth</b>	<b>Complete Pest Management Services</b> Kimberley Lawrence	08 9248 9929
<b>Perth</b>	<b>Envirotechnics</b> Peter Adam	08 9231 4744
<b>Perth</b>	<b>Termico Pest Management Services</b> Richard Slee	08 9443 9880
<b>South East Coast WA</b>	<b>Key Pest and Weed Control</b> Richard Braybrooke	08 9071 2528
<b>Southern WA</b>	<b>Murray River North Pty Ltd</b> Ian Mclarty	08 9531 2033



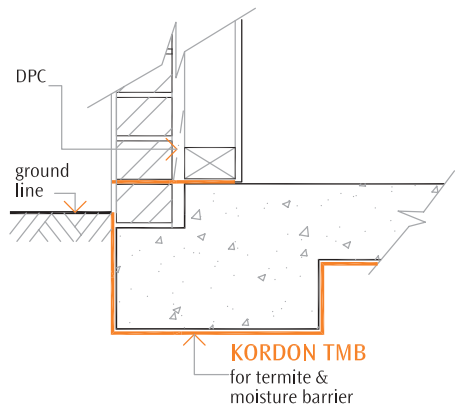




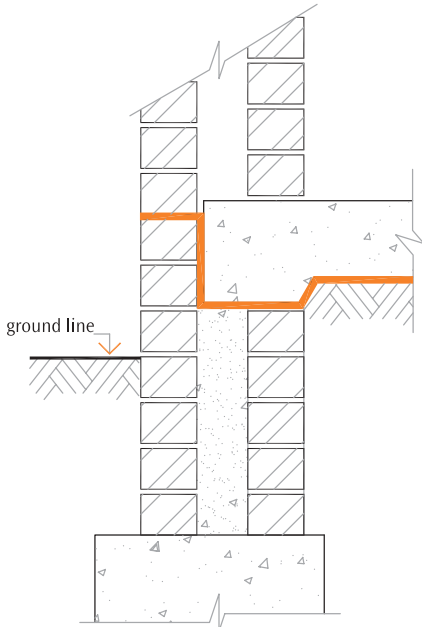
section



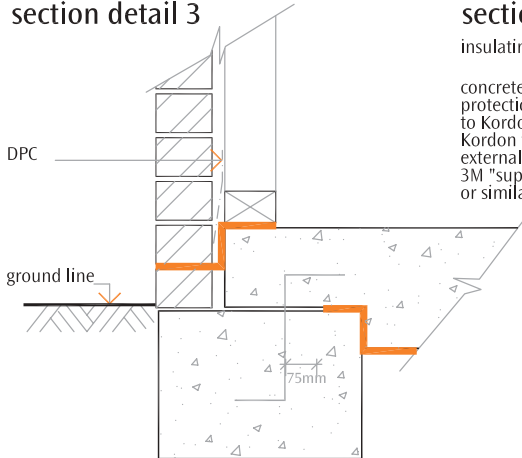
section detail 1



section detail 2

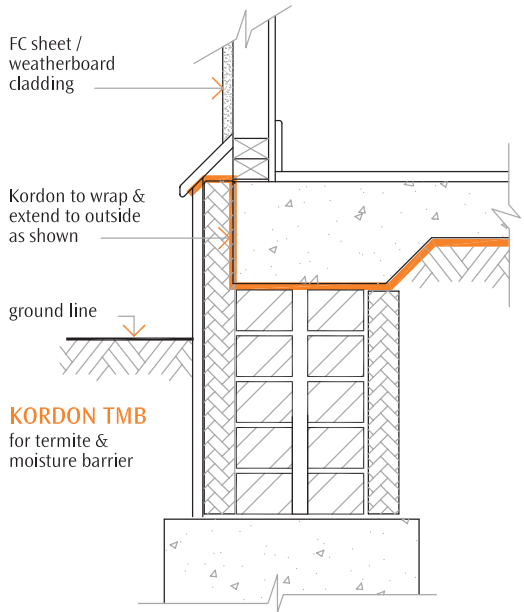


section detail 3



section detail 5

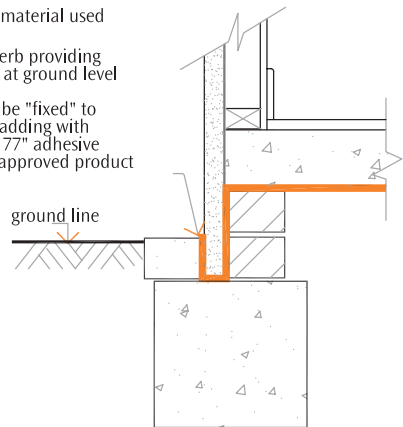
non-monolithic slab



section detail 4

insulating material used

concrete kerb providing protection at ground level to Kordon. Kordon to be "fixed" to external cladding with 3M "super 77" adhesive or similar approved product



section detail 6

insulation type cladding



Photo 1



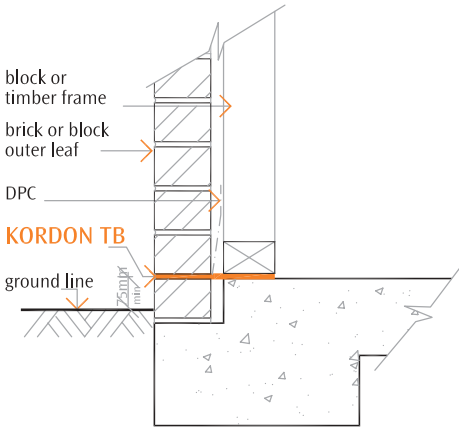
Photo 2  
waffle pods



Photo 3  
deep trenching

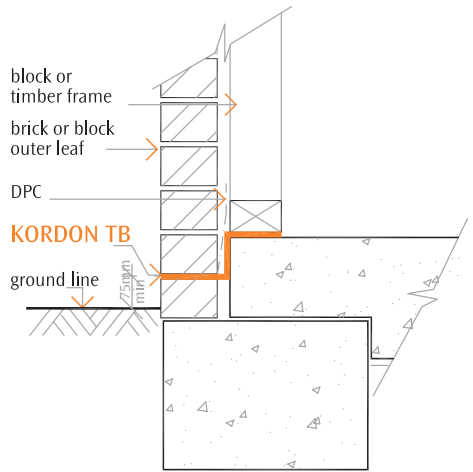


**KORDON TB  
PERIMETER**



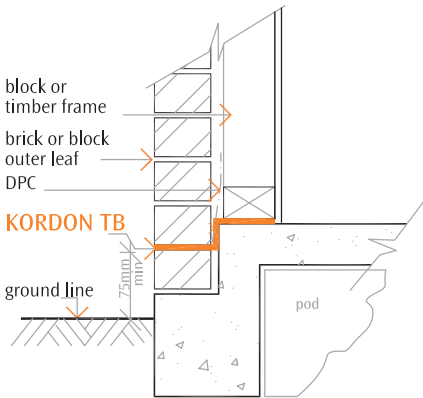
section detail 1

1 brick rebate



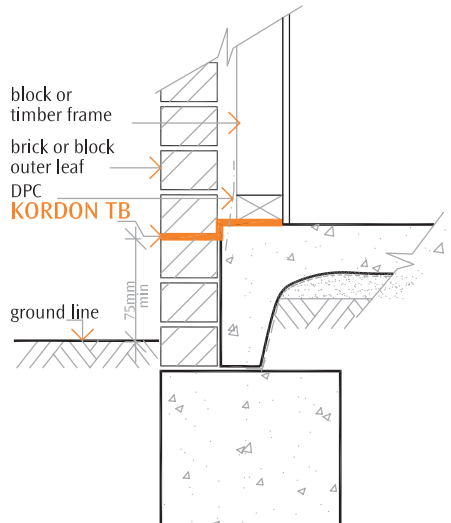
section detail 2

2 brick rebate



section detail 3

waffle pod

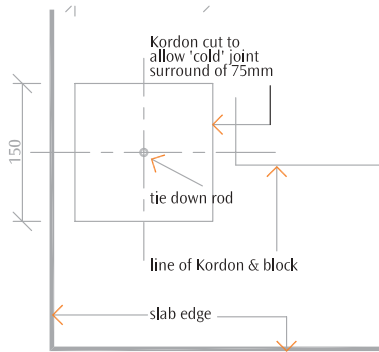


section detail 4

infill slab

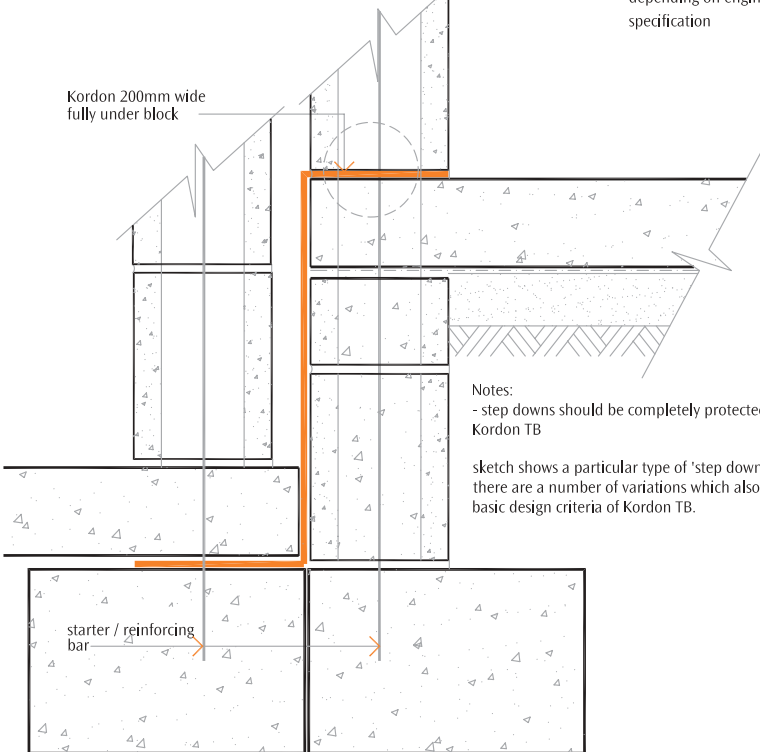


photo 1



Alternative plan detail depending on engineers specification

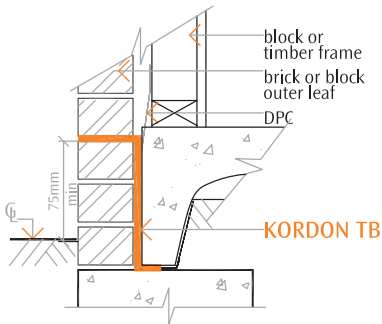
plan detail



Notes:  
- step downs should be completely protected with Kordon TB

sketch shows a particular type of 'step down' installation. there are a number of variations which also follow the basic design criteria of Kordon TB.

Before installing Kordon TB, clean off all excess mortar from the top of the third layer of bricks and to the vertical of the internal brickwork. This is to allow the Kordon TB to be sandwiched between the concrete slab and the brickwork, without unnecessary undulations.

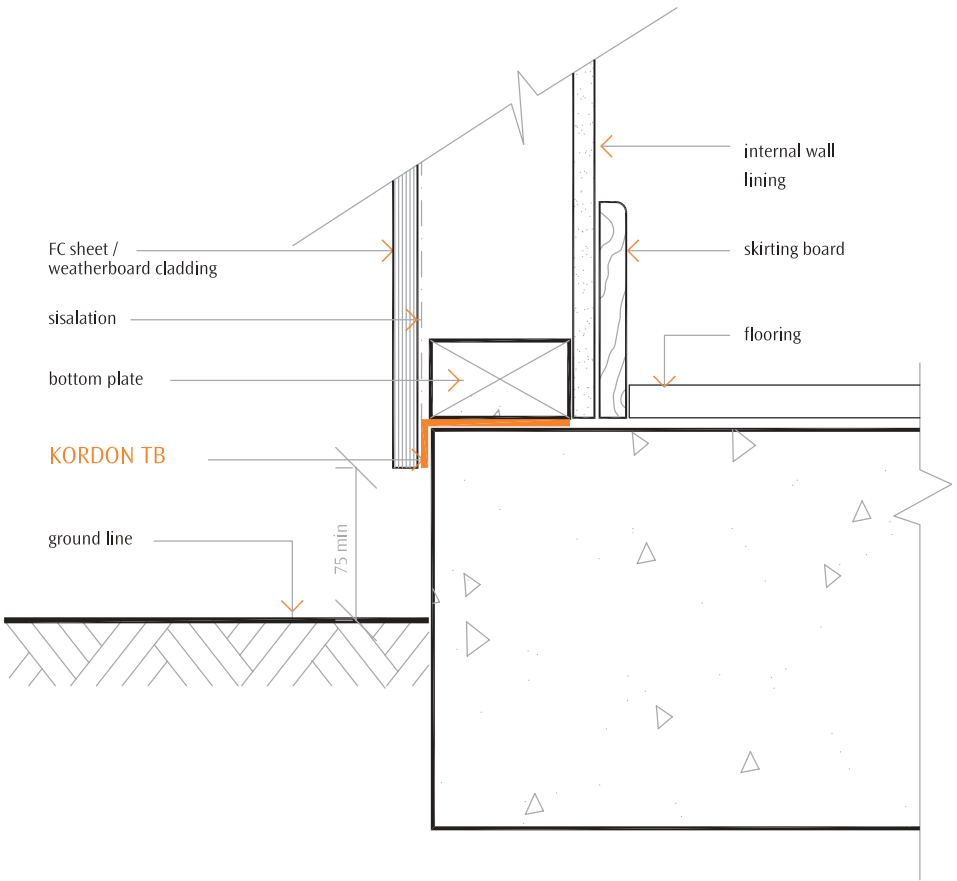


Install 400mm approx length of Kordon TB to internal corner as shown. Product to sit on footing a minimum of 75mm from starter bar. Secure to brickwork with clouts into mortar joints.

Install 300mm Kordon TB to external perimeter of brickwork and cut vertically at internal corner. Tape to existing corner piece. Secure clouts into mortar both horizontally and vertically.

Install 300mm Kordon TB to other side of brickwork, taping product with a minimum of 50mm overlap and secure as above.









## THE PROCESS IN STAGES:-

- Protect service penetrations paying particular attention to service inlets eg power, water etc - refer kd 009
- After the pour, chalk lines for positioning of timber frames to be in place before commencing installation.
- Install Kordon to service inlets refer kd 009,
- Determine the width of Kordon required by communicating with the builder/ bricklayer as to how many bricks are to be installed to the footing to get to DPC level. Keep in mind this may vary due to step downs---plan ahead , decisions at this stage will have a bearing on the following installation stages.
- Install Kordon to the chalk lines by fixing to the slab with approx 15 mm concrete nails @ maximum of 350 mm centres.  
3M spray adhesive or similar approved adhesive may be used only as an extra
- Ensure you nail the corner overlaps together so as to minimise Kordon movement when timber frames are stood
- Ensure you allow enough overlap for areas such as bay windows and nail these overlaps together to minimise Kordon movement when timber frames are stood
- Nailing with power tools is an option, be aware that the nail heads must finish flush with the slab, so as not to create gaps or undulations when the frames are stood and care should be taken not to damage the slab edges
- The bricklayer now lays the bricks to the footing to the height of the DPC level.
- You are now required to install the Kordon to the brickwork setting the corners as per your installation details.
- These corners, including bay window situations are to be fixed with both 3M spray adhesive or similar approved adhesive , and a quality cloth tape
- A 3-4 mm strip of 3M Spray Adhesive to the brick edge will keep the Kordon in place.
- Attention to sill/entry/sliding doors, refer to kd048b - kd048c
- At this stage you are now in a position to check your perimeter installation and note if any disturbance has taken place, and extra plumbing / services pipes have not been added which will require rectification.
- You now remove any off-cuts and note if you will be required to make any further site visit. eg to install Kordon across the driveway, wheel chair access, patios, columns etc
- Place the meter box sticker only after you have completed the installation and are prepared to sign it off .



1.

incorrect installation - Kordon TB not installed to frame chalk line



2.

Kordon TB with timber frames in place



3.



4.

3 & 4, Kordon TB pinned to frame whilst bricks are layed to Damp Proof Course level



5.



6.

5 & 6, Kordon TB secured to outer brick edge with spray adhesive/doubs



7.



8.

7 & 8, external, internal corners, overlapped, folded, secured with spray adhesive and cloth tape.

### Knock out block work

This installation procedure refers to situations where tie down rods are visible after the concrete pour. The alternate plan detail is dependent on the engineer's specification.

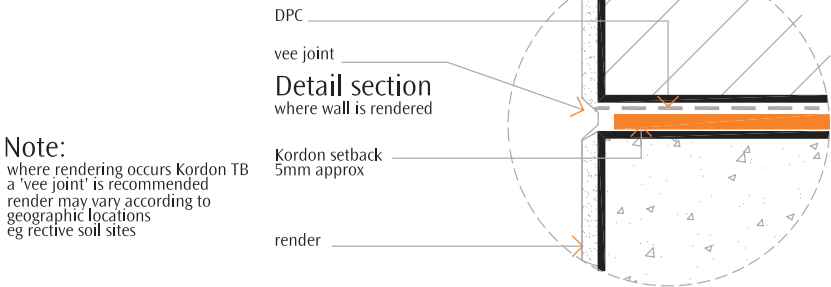
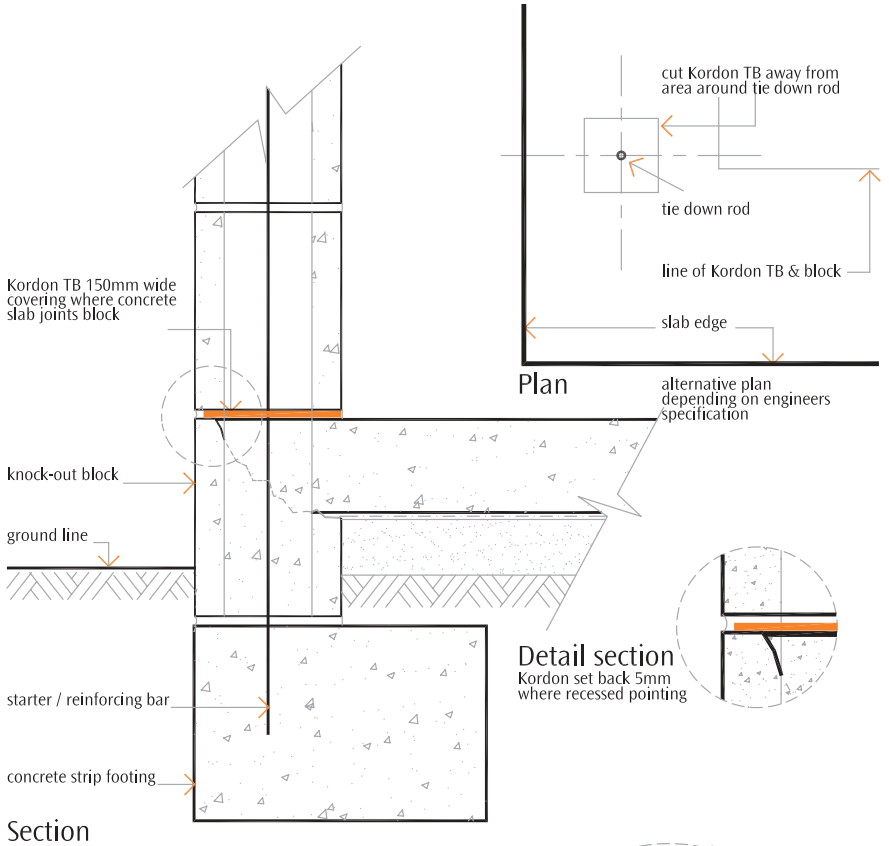
- Install approx 150mm width strip of Kordon TB to top of slab edge, cutting the product from the inside to allow for the tie down rod.
- Wrap a 20mm X100mm strip of Kordon TB to the base of each rod and secure with a zip tie.
- Install a patch of Kordon TB approx 100mm X 100mm. Using a 6mm wad punch insert overlap. Tape the product as indicated in the photo attached.
- Electrical and communication service points must be protected as per normal pipe installation details.

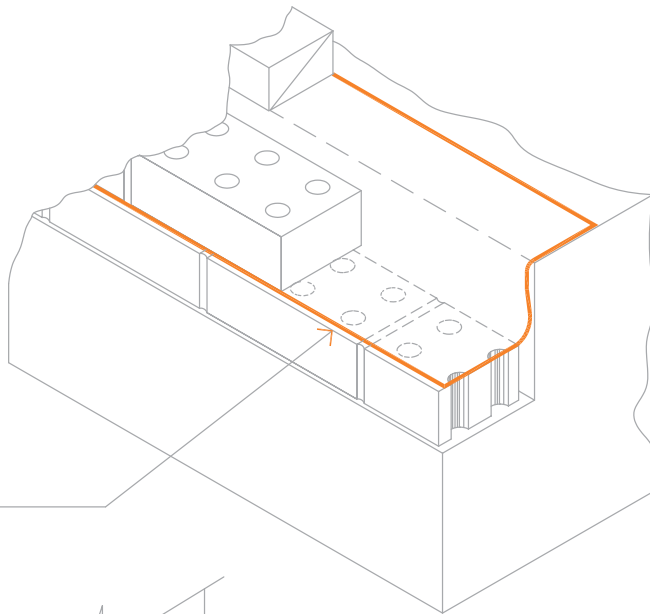
### RENDERED BRICK AND BLOCKWORK.

Where a rendered finish is specified the following is recommended:

- A 'V' (vee) joint is applied at the Kordon TB /DPC level
- A mechanical joint is applied at the Kordon TB /DPC level.

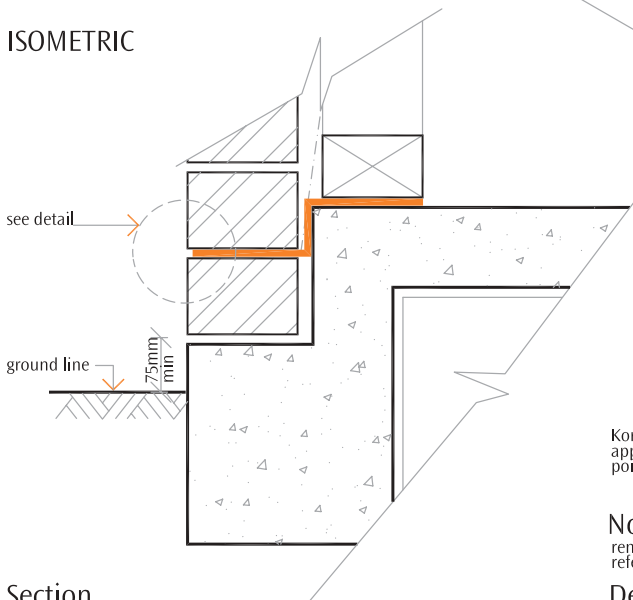






**Note:**  
it is important to ensure that Kordon TB cover all perforations within wirecut bricks or blockwork

## ISOMETRIC



## Section



Kordon TB set back 3mm approximately where recessed pointing / raking occurs

**Note:**  
rendered wall refer to 008/d

## Detail



- Product required for one slab pipe penetration:-
- 2 x 300mm x 300mm Kordon TB patches
  - 2 x 450mm cable ties
  - 1 x 40mm x 400mm Kordon TB collar strip
  - quality duct tape



2. cut a cross in centre of patch , slide patch over pipe
3. secure Kordon collar strip to pipe over lap patch turn up
4. complete collar with duct tape
5. prepare 2nd patch fold in half twice



6. press firmly folded corner over 1/3th of pipe diameter
7. check rim indent is visible
8. cut along rim indent with quality scissors



9. push patch over pipe this should be a tight fit
10. 2nd patch should produce a turn up lip at base of pipe
11. 1st zip tie secured at the turn up lip level
12. secure 2nd zip tie to top of pipe collar



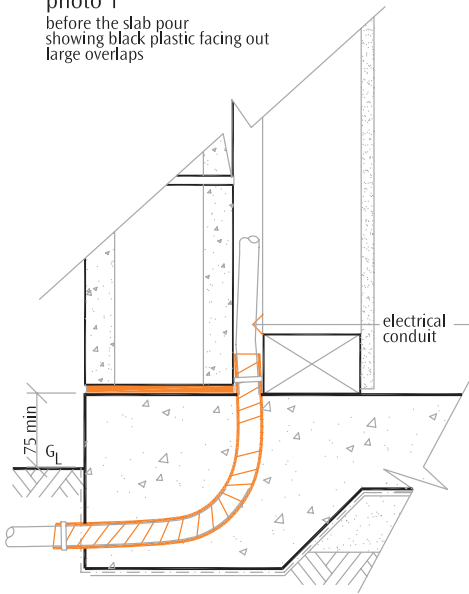
13. trim zip tie extensions
14. complete tape down
15. complete patch tape down
16. remove off cuts from site



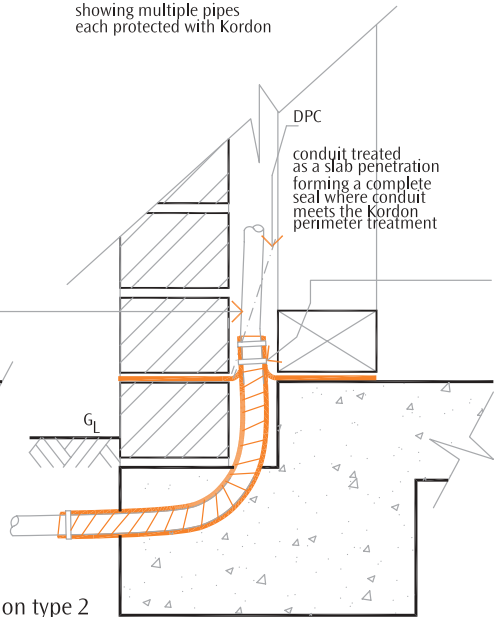
photo 1  
before the slab pour  
showing black plastic facing out  
large overlaps



photo 2  
showing multiple pipes  
each protected with Kordon



section type 1



section type 2

Notes:

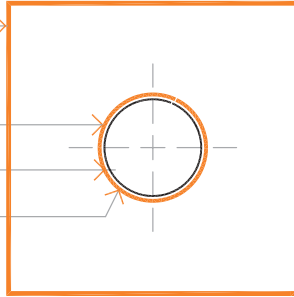
- wrap Kordon TB around (with overlap) electrical conduits penetrating the slab at length of 300mm approx.
- Kordon TB should be visible after the pour on any conduit /water pipe.
- a cable tie is to be secured at the start and at the finish of the wrap
- where possible place a 300x300 Kordon TB patch at the base of the slab penetration.
- where a cluster of conduits are installed - each conduit must be wrapped separately as above.

**Kordon Kollar**

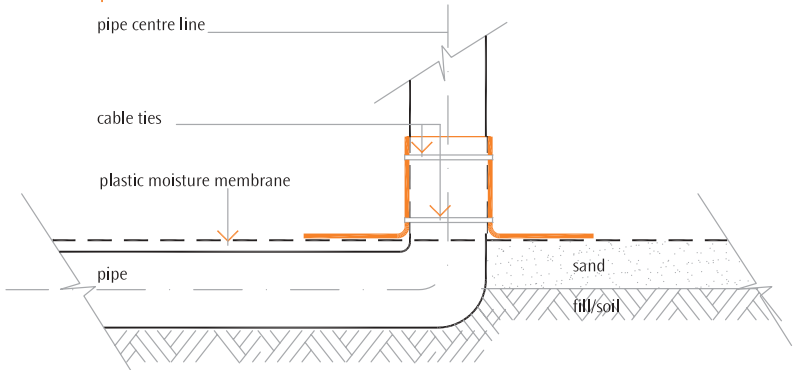
place Kordon Kollar over pipe until Kollar flange sits on the plastic membrane

place first zip tie base of collar and tighten overlap each side  
100mm dia pipe

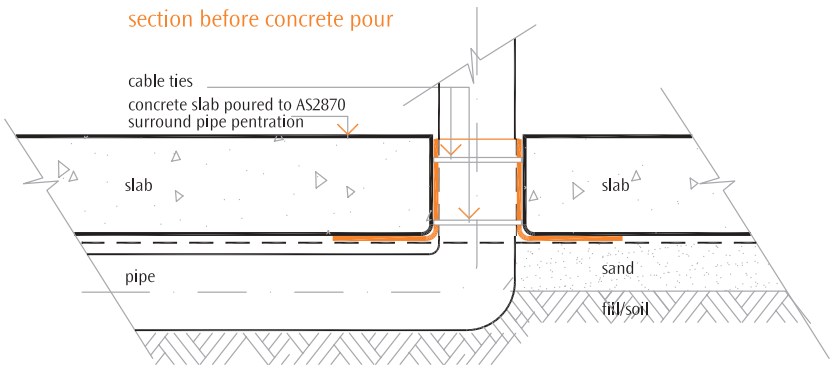
place second zip tie 50mm approx higher then first zip tie



**plan**



**section before concrete pour**



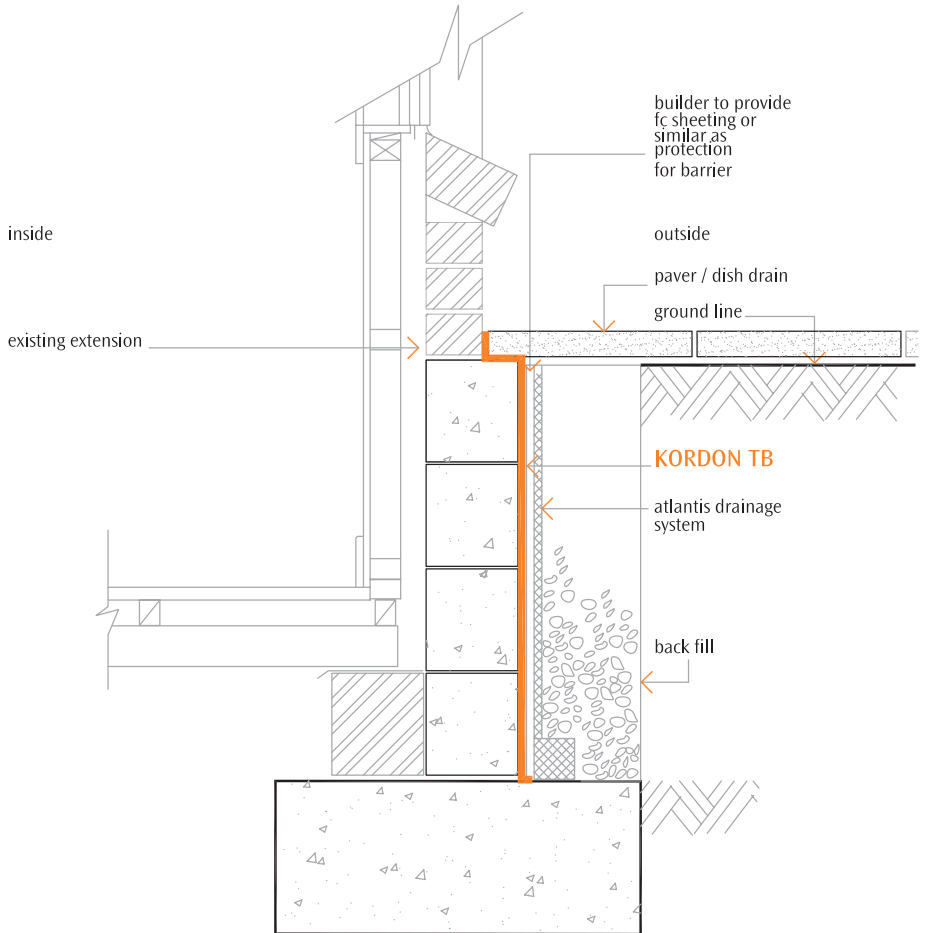
**section after concrete pour**

**Kordon Kollar installation**

- Step 1: place Kordon Kollar over pipe slide down to the DPM plastic
- Step 2: secure first zip tie to base of kollar, secure second zip tie 50mm higher then first

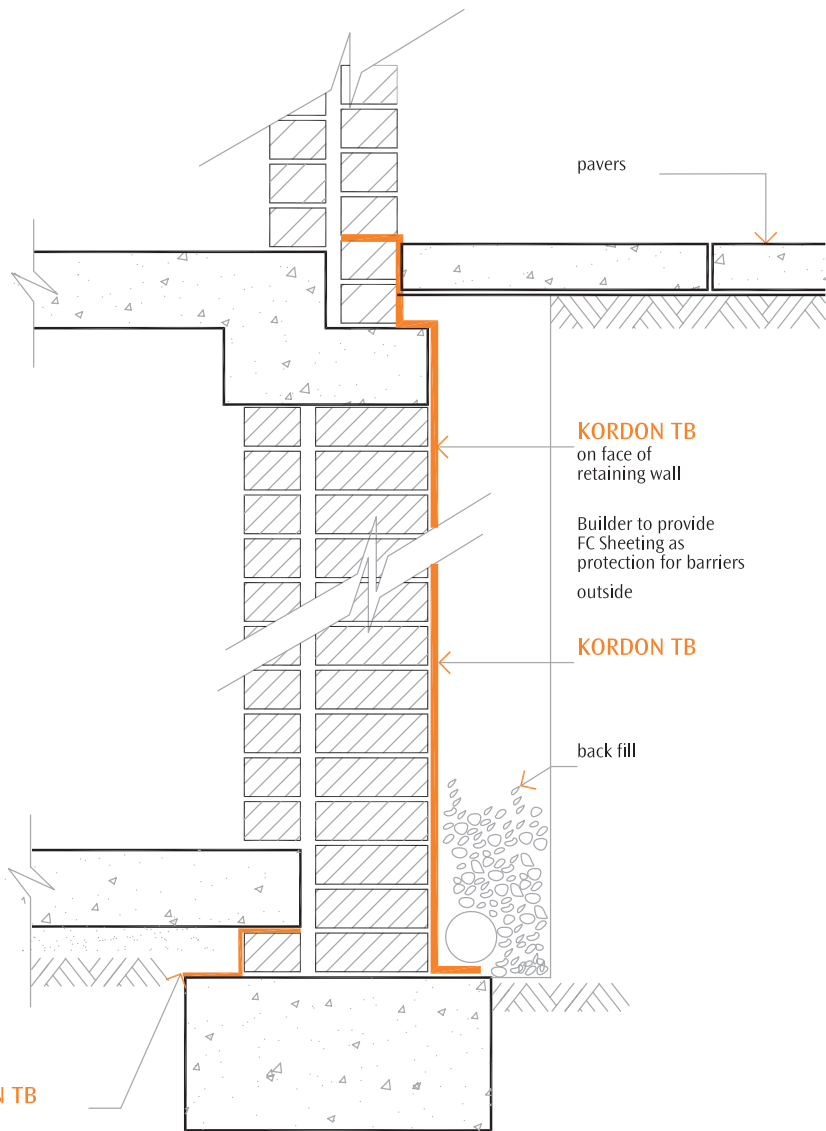


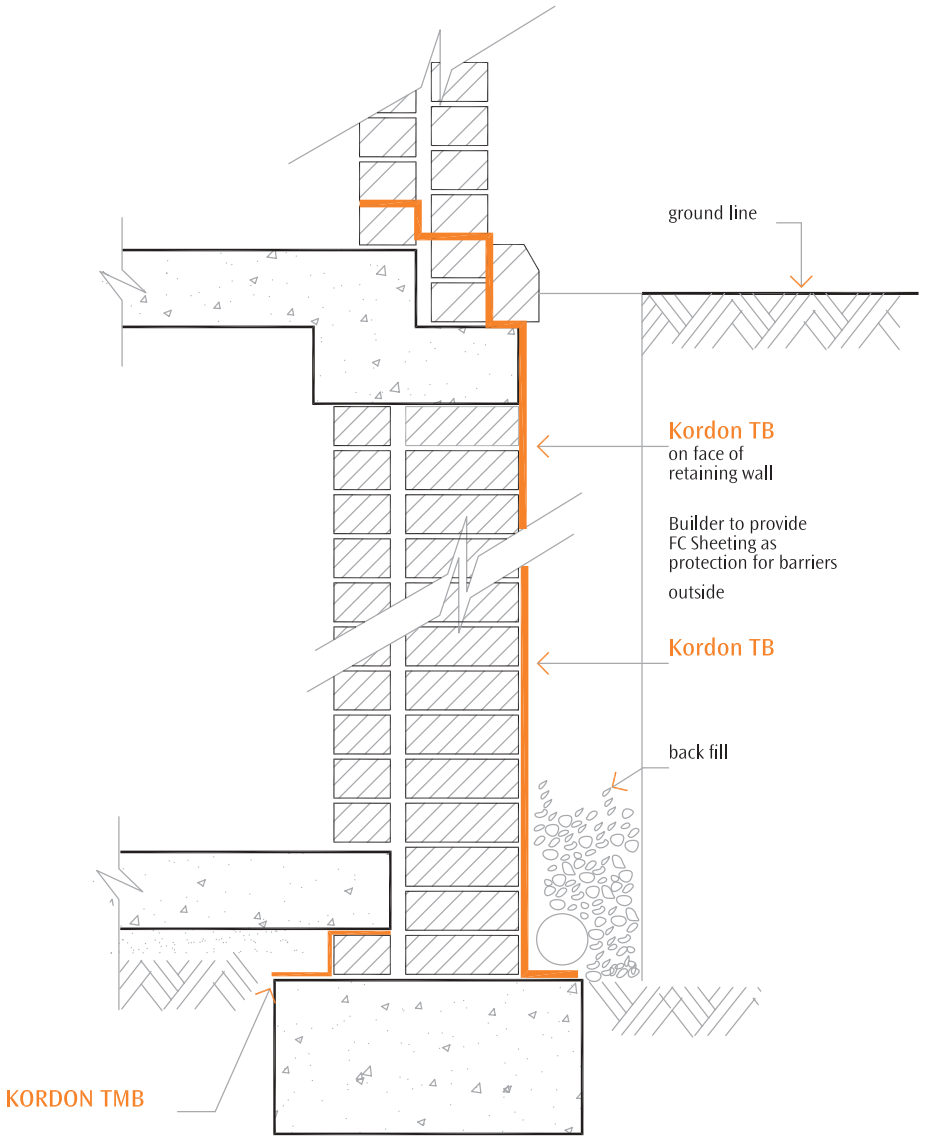


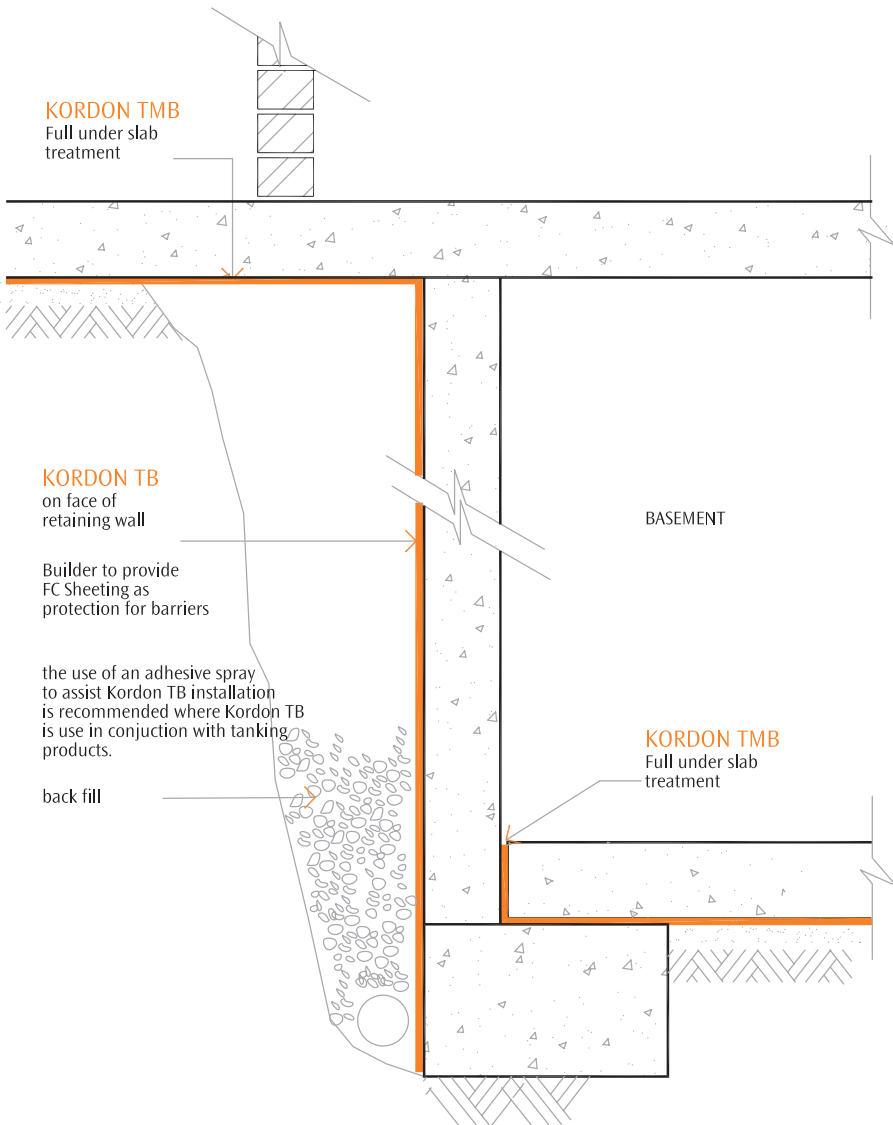


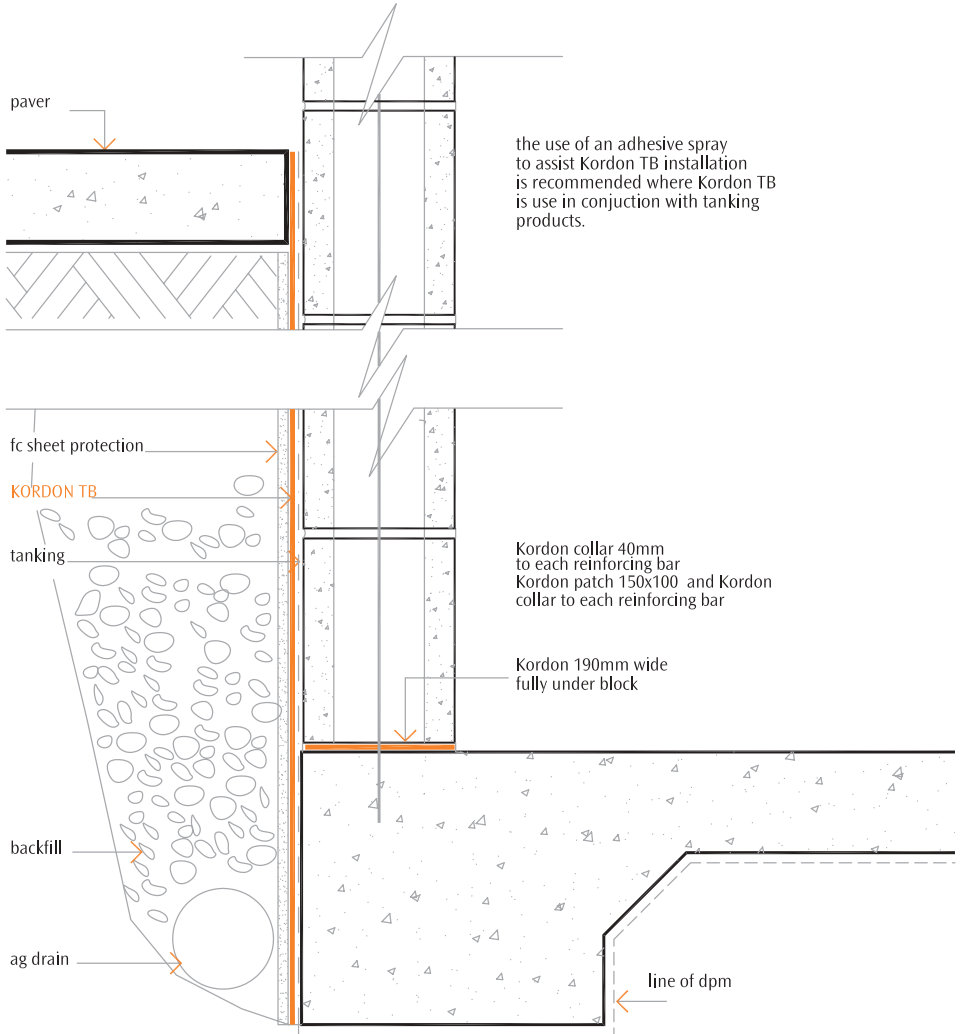
Note:  
the sketch above shows a renovation  
to an existing building

it is strongly recommended that the existing  
building has a termite inspection before  
any new works.









the use of an adhesive spray to assist Kordon TB installation is recommended where Kordon TB is used in conjunction with tanking products.

**KORDON TB**

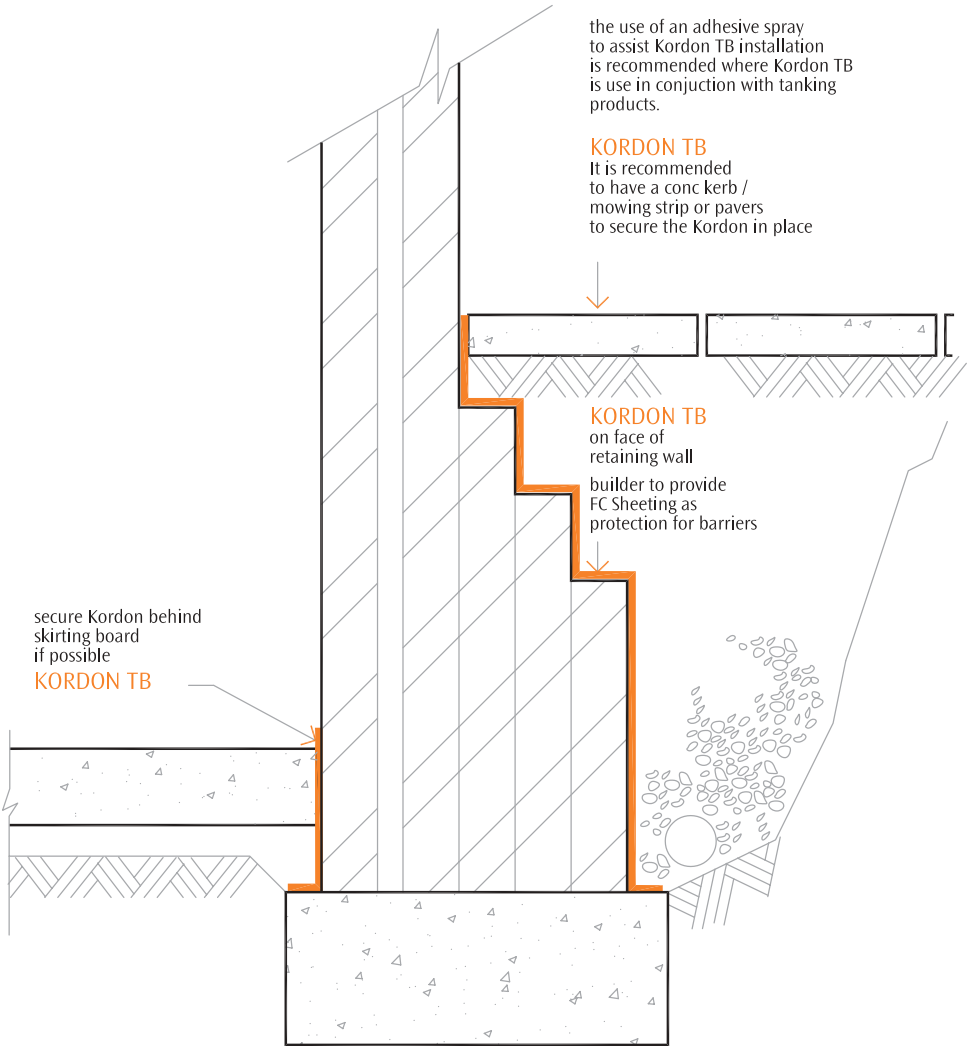
It is recommended to have a conc kerb / mowing strip or pavers in place to secure the Kordon in place

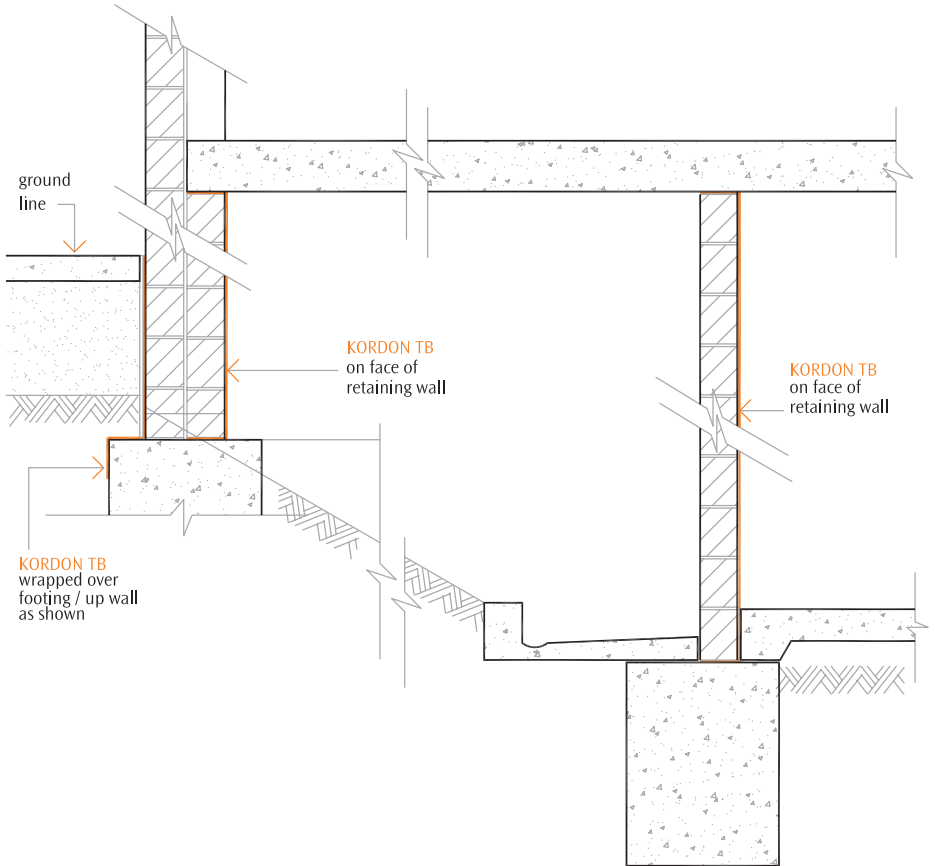
**KORDON TB**  
on face of retaining wall

builder to provide FC Sheeting as protection for barriers

secure Kordon behind skirting board if possible

**KORDON TB**





Note:  
 in the above installation. Kordon TB  
 would be installed using additional installation  
 tools of adhesive spray and Hoop Iron bracing.





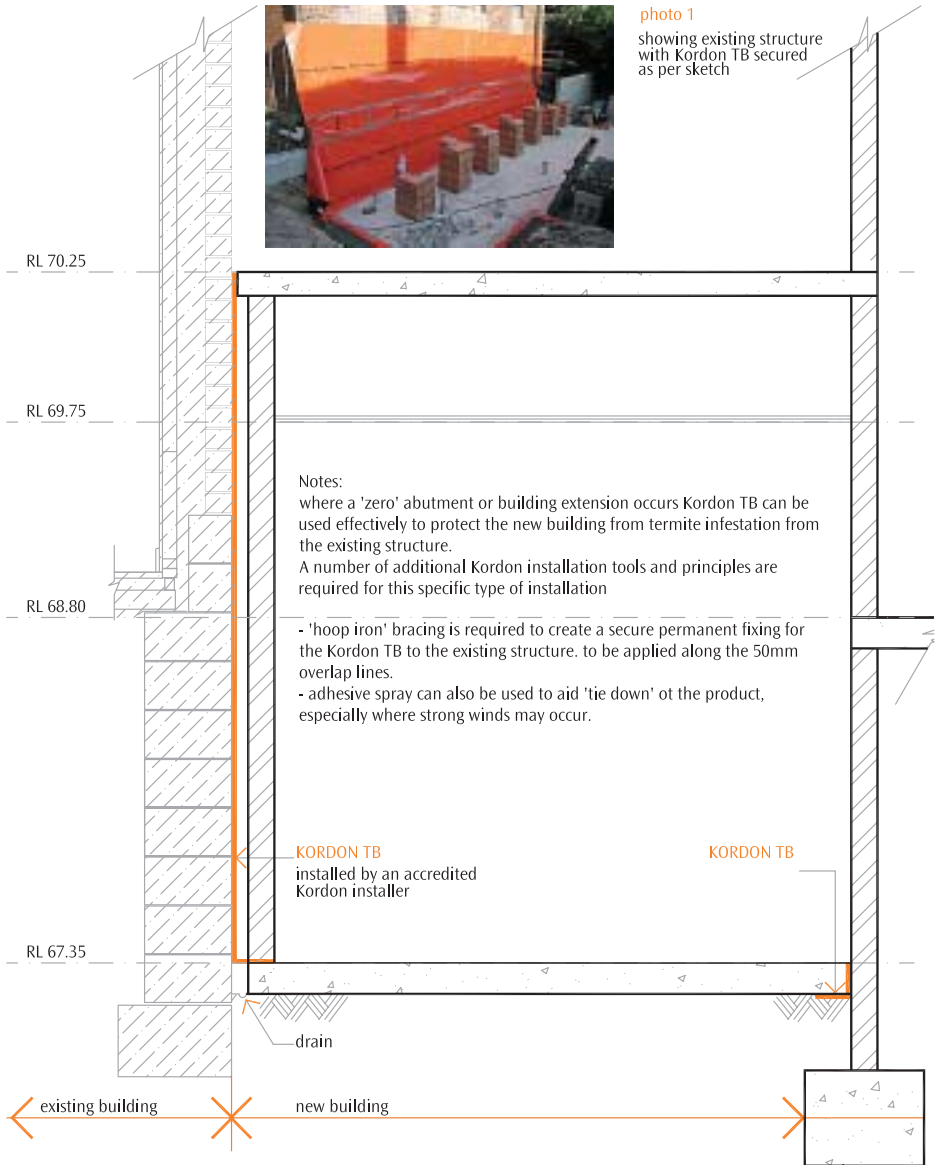
**Photo 1**  
Kordon TB - full retaining wall



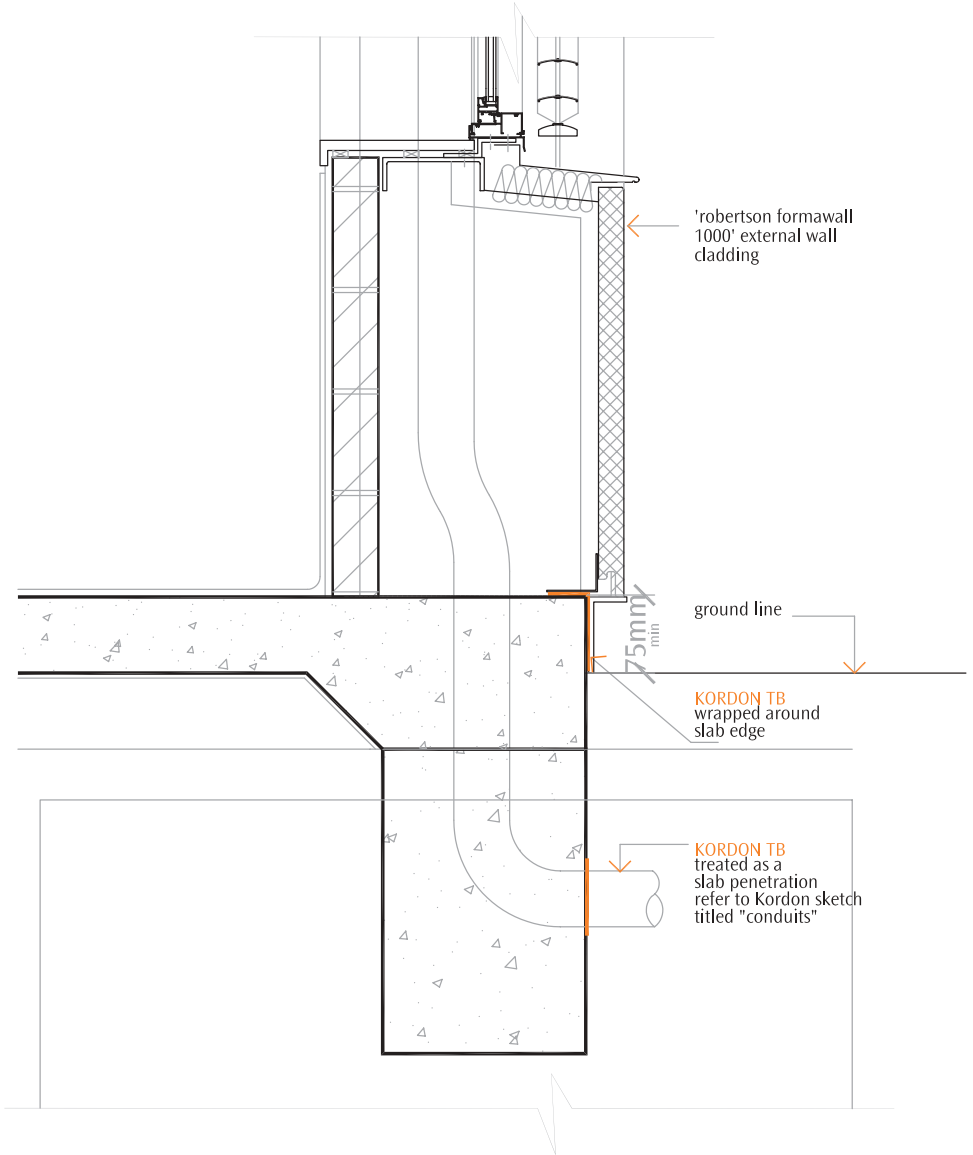
**Photo 2**  
Kordon TB - retaining/stepdown

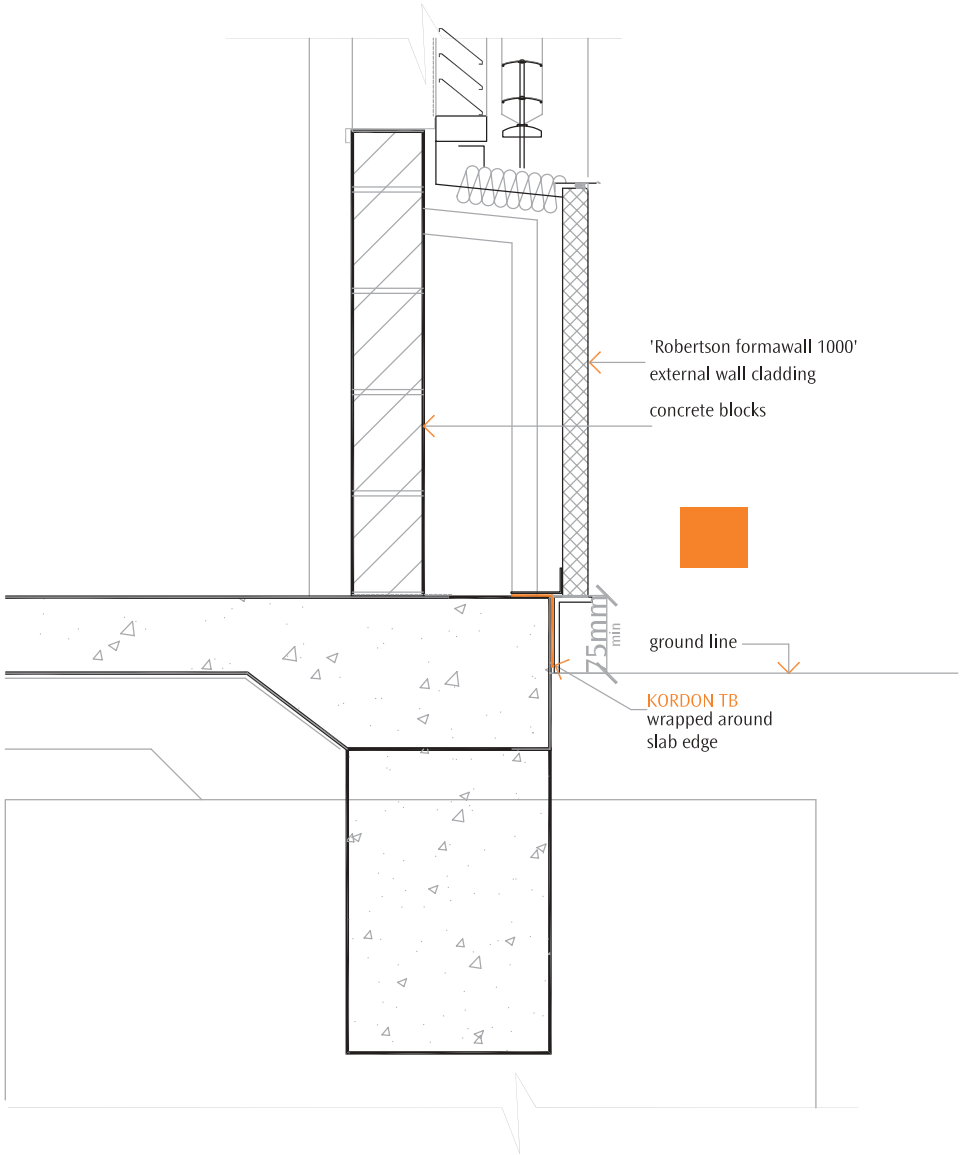


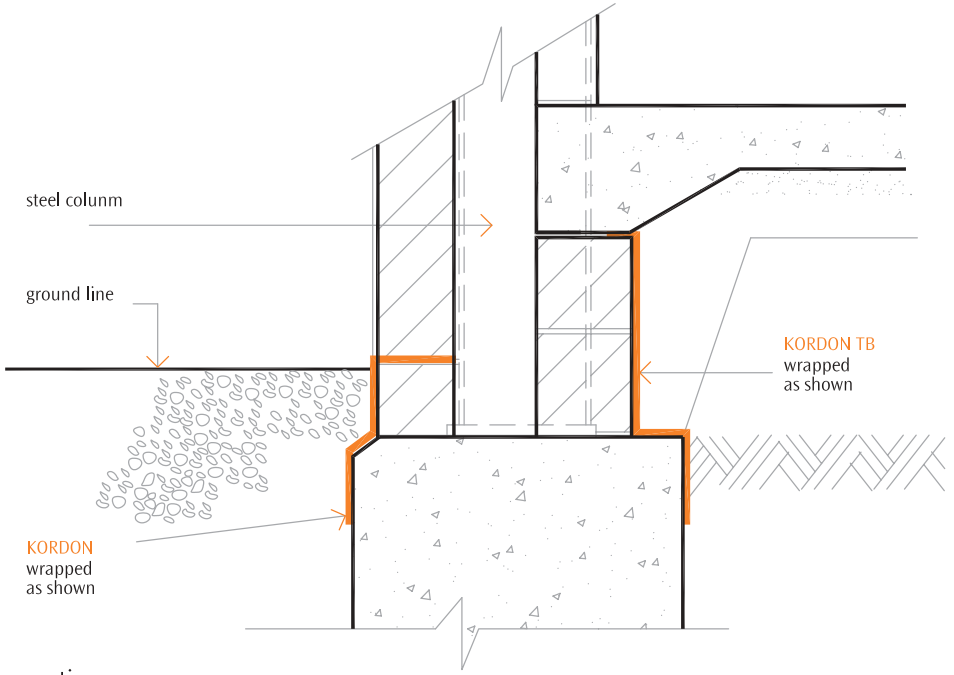
**Photo 3**  
Kordon TB - internal wall treated



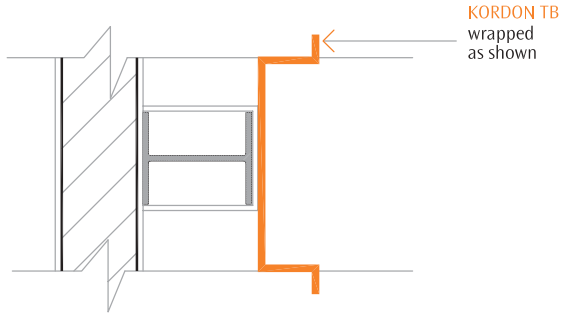




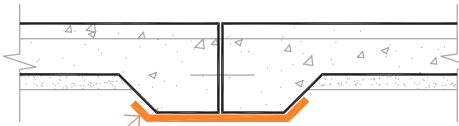




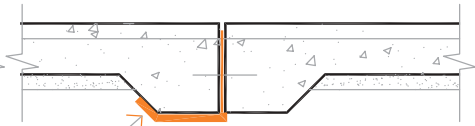
section



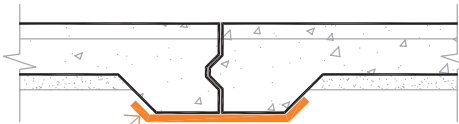
plan



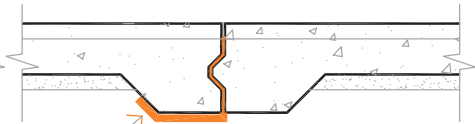
KORDON TB  
dowel joint - option A



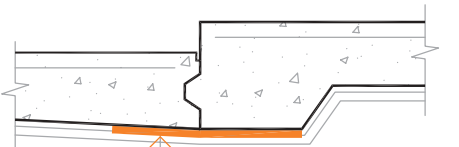
KORDON TB  
dowel joint - option B



KORDON TB  
key joint - option A



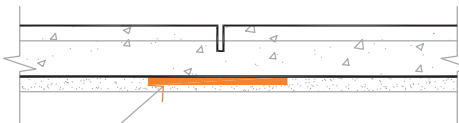
KORDON TB  
key joint - option B



KORDON TB  
taped on top  
of DPM - option A



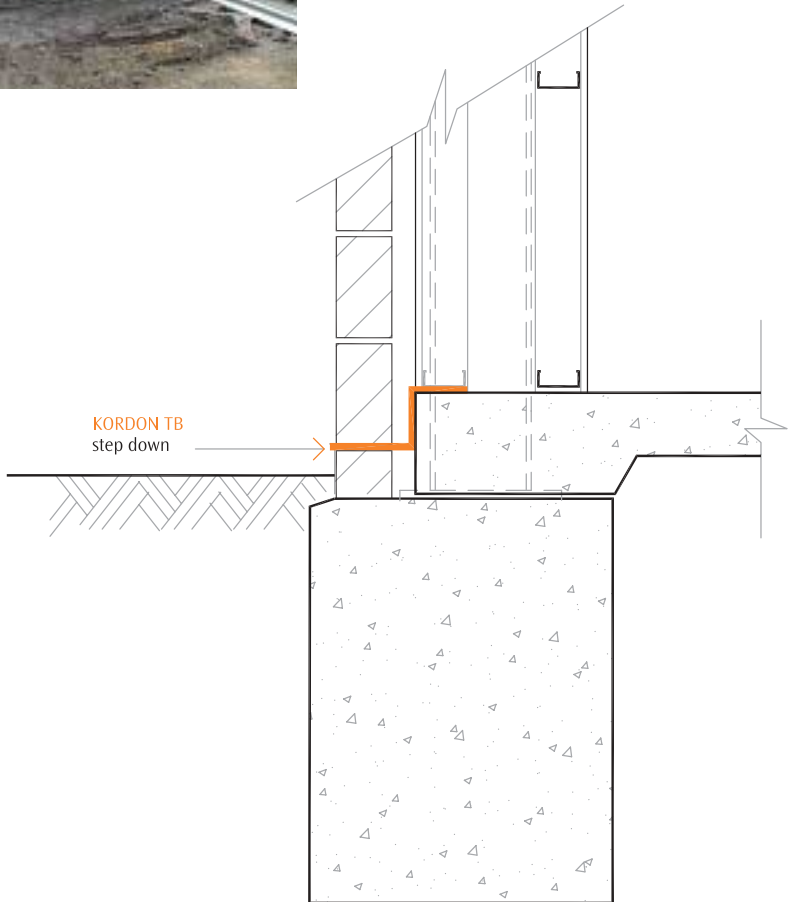
KORDON TB  
taped on top  
of DPM - option B



KORDON TB  
saw joint



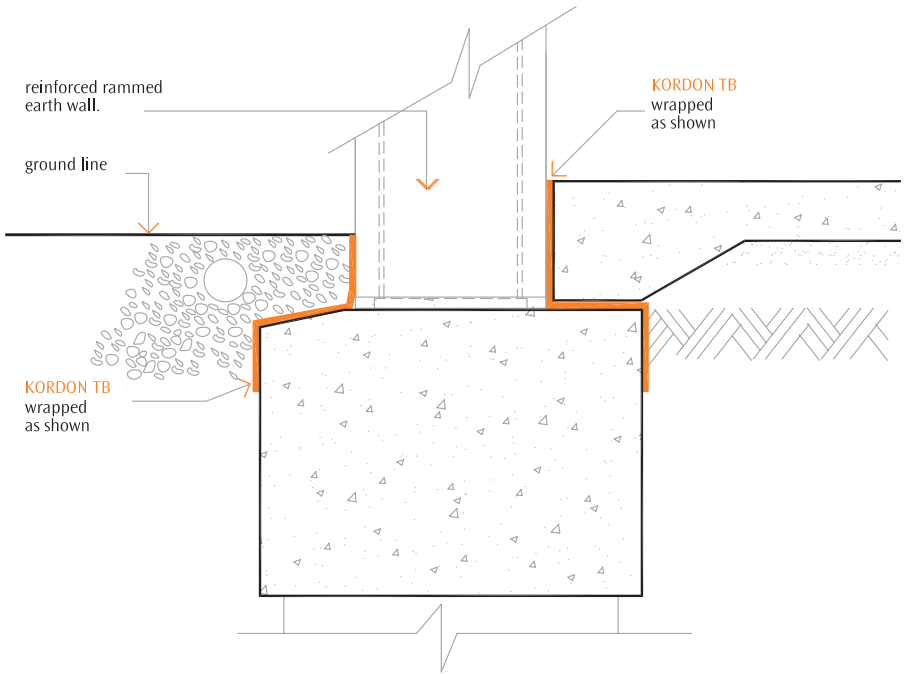
Photo 1  
Kordon TB -commercial building

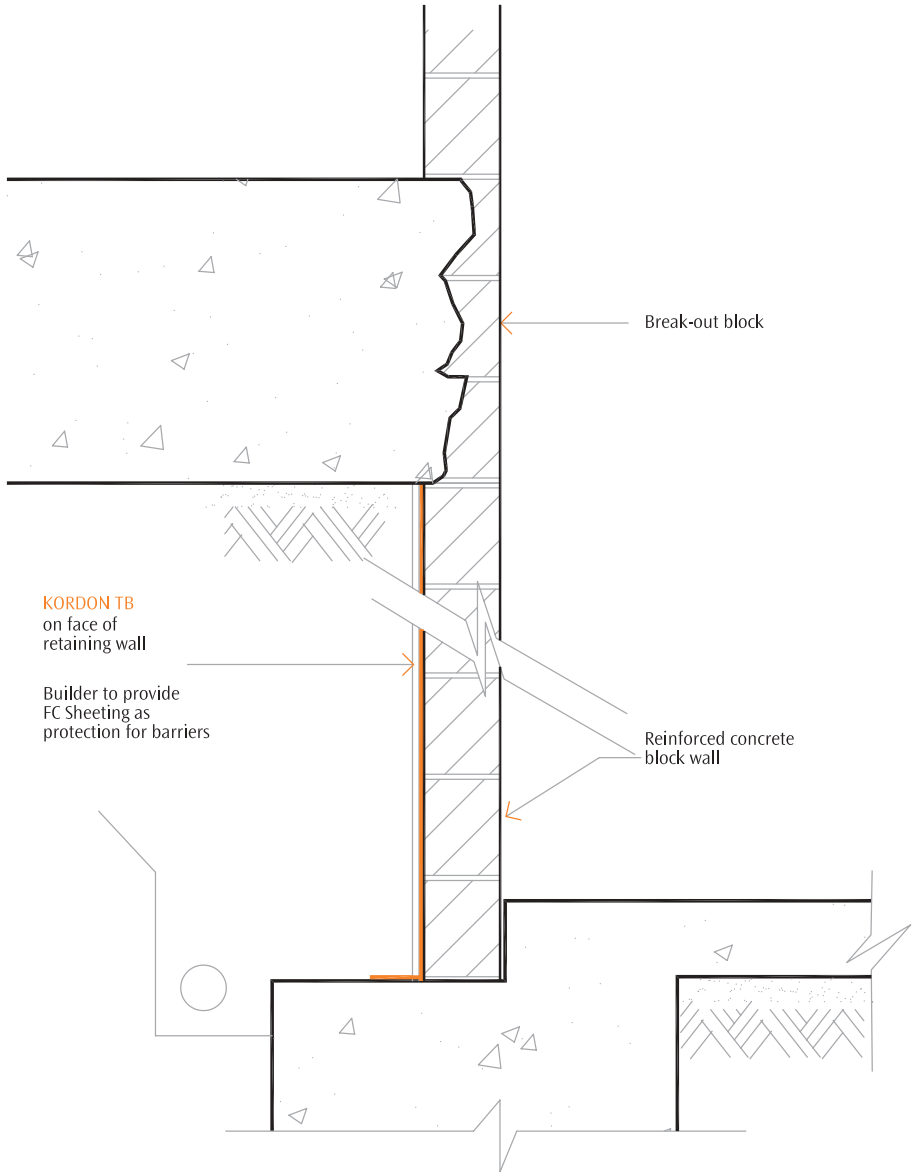




concrete column  
infill surround  
concrete

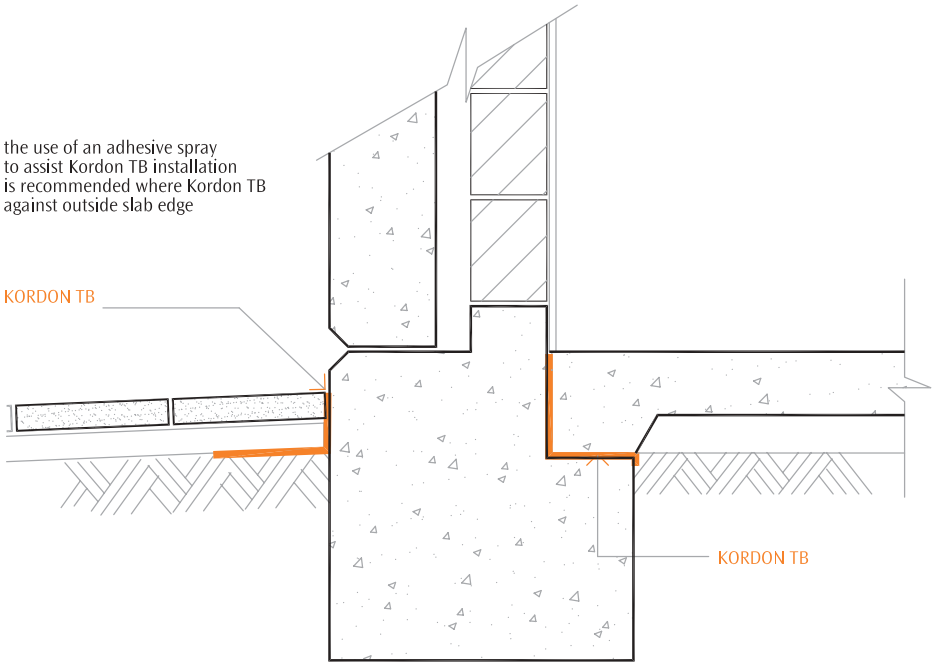
KORDON TB





the use of an adhesive spray to assist Kordon TB installation is recommended where Kordon TB is against outside slab edge

KORDON TB



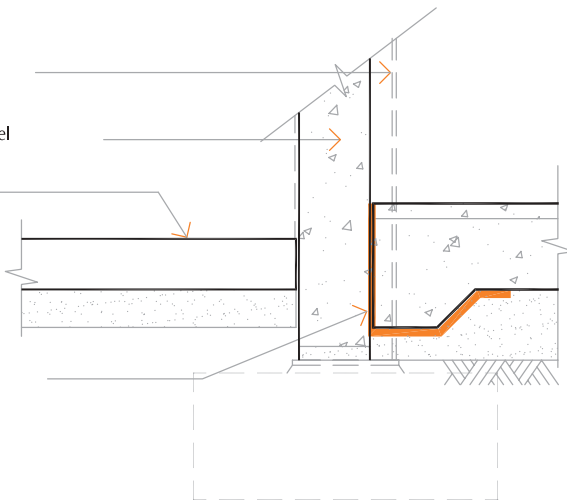
KORDON TB

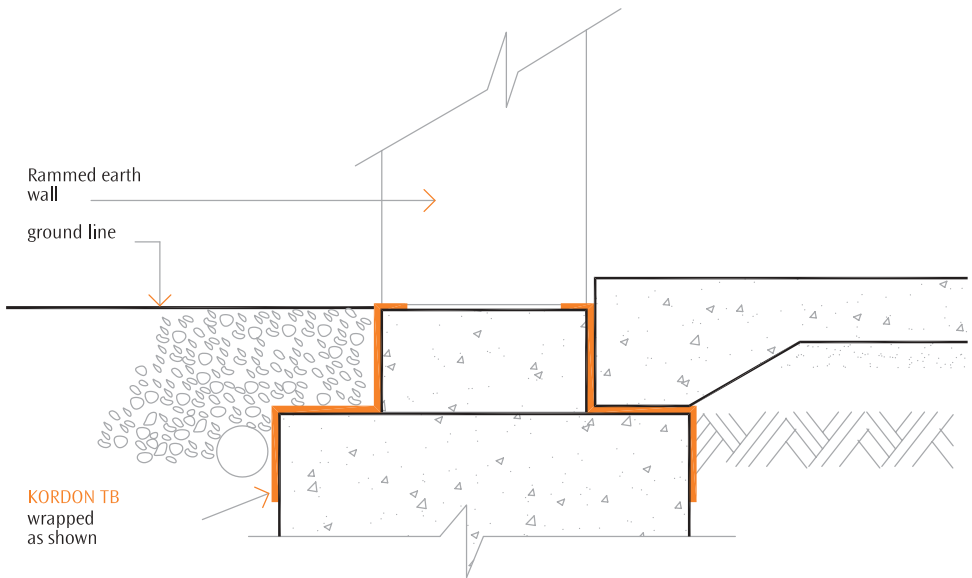
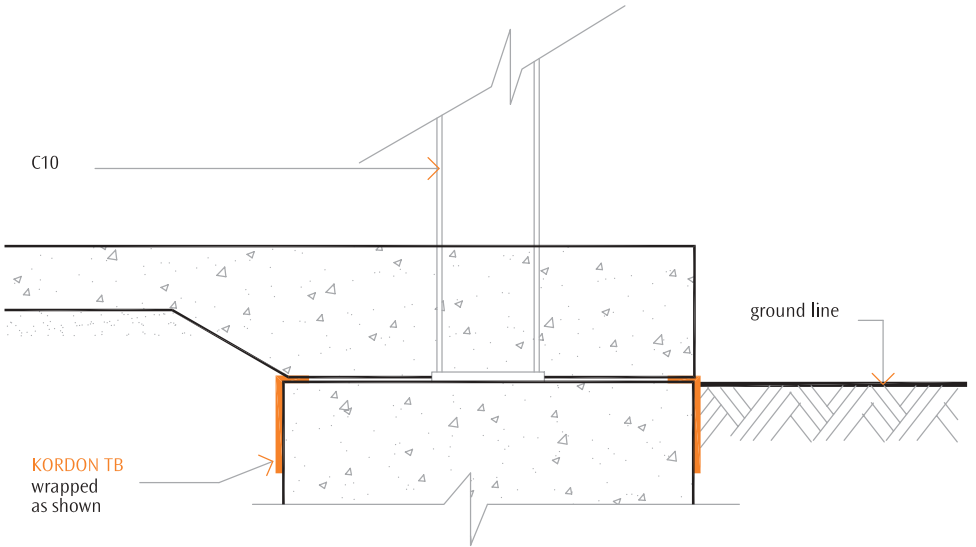
steel column  
beyond

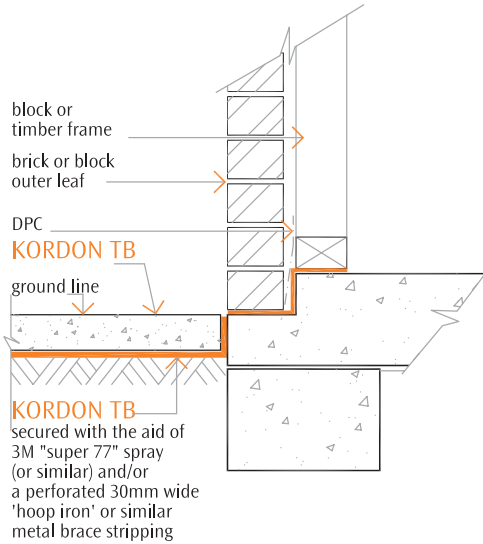
precast wall panel

outside concrete  
paving

KORDON TB





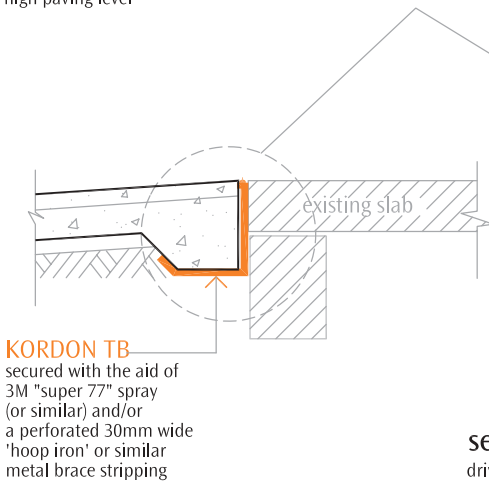


**photo 1**

garage entry detail  
secured with the aid of 3M "super 77" spray or similar  
Note:  
where various slab conditions prevail i.e. rough or damaged:-  
It is important to establish a full seal to the perimeter is achieved

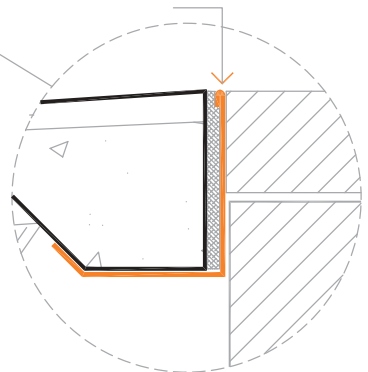
**section detail 1**

high paving level



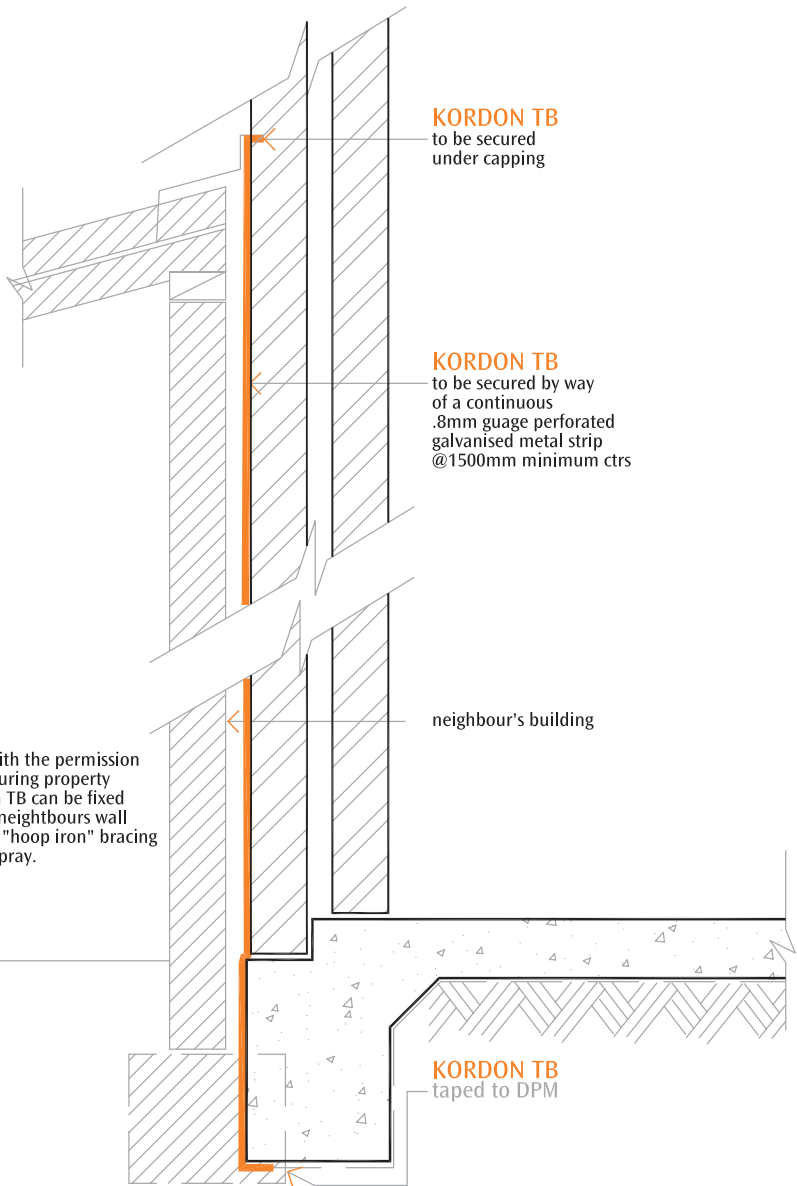
**KORDON TB**

30mm fold back  
note: expansion material also protected by Kordon TB

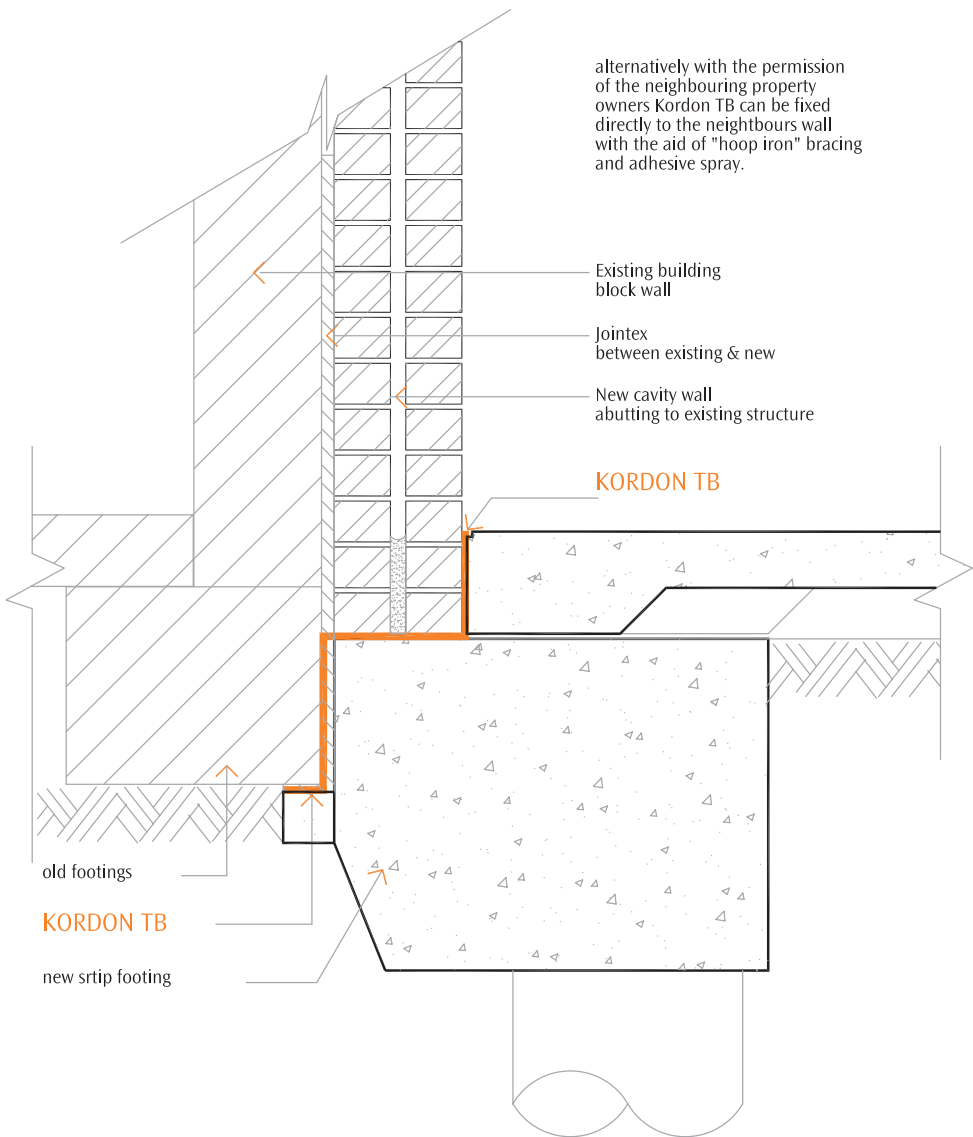


**section detail 2**

driveway

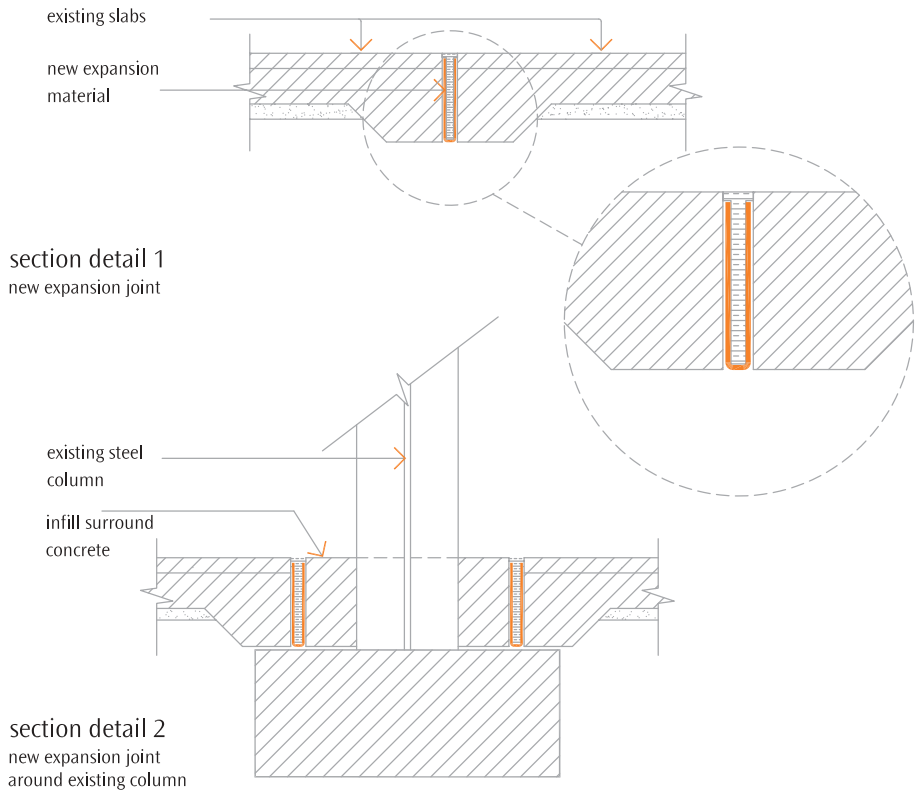


alternatively with the permission of the neighbouring property owners Kordon TB can be fixed directly to the neighbours wall with the aid of "hoop iron" bracing and adhesive spray.

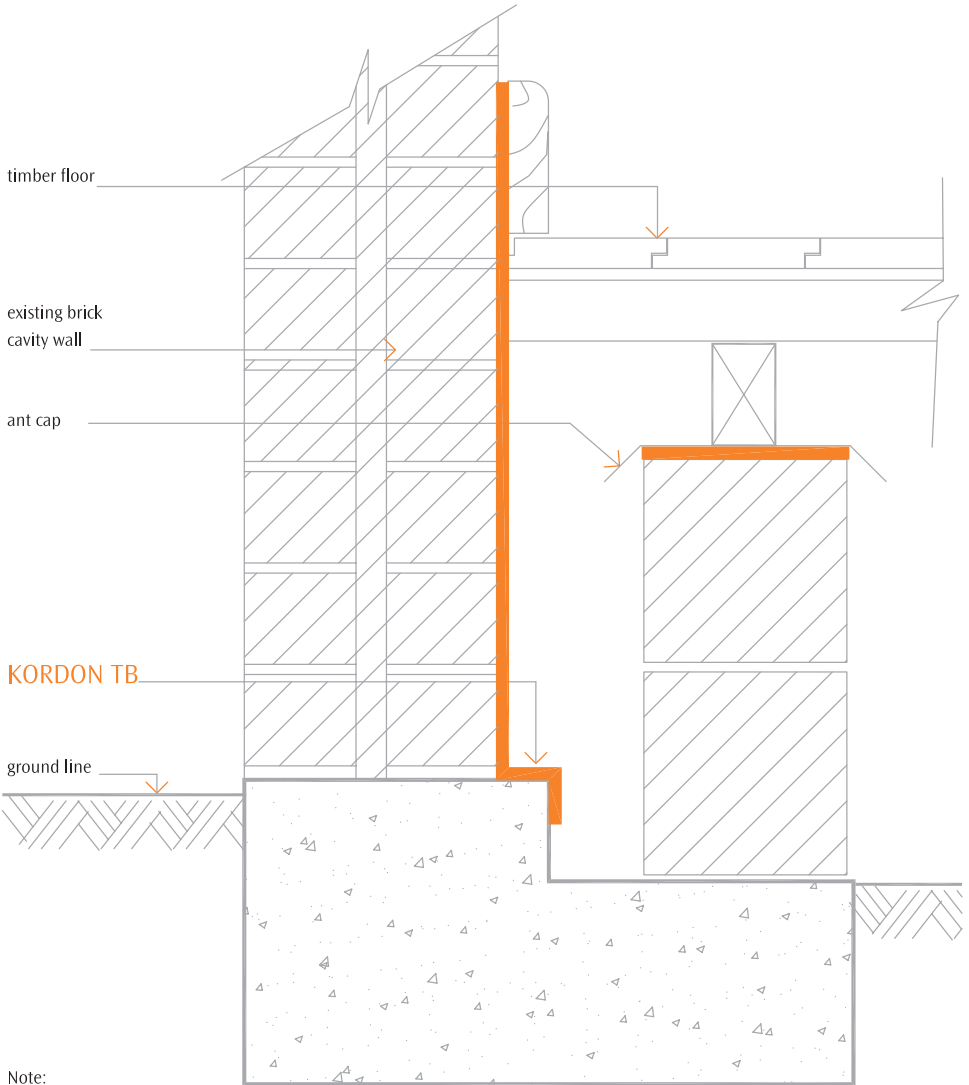


sketch below shows a existing slab floor to a factory  
the expansion material has deteriorated over time and in need of  
replacing.

It was suggested that in replacing the expansion material Kordon TB  
could be installed to assist the pervention of concealed termite entry

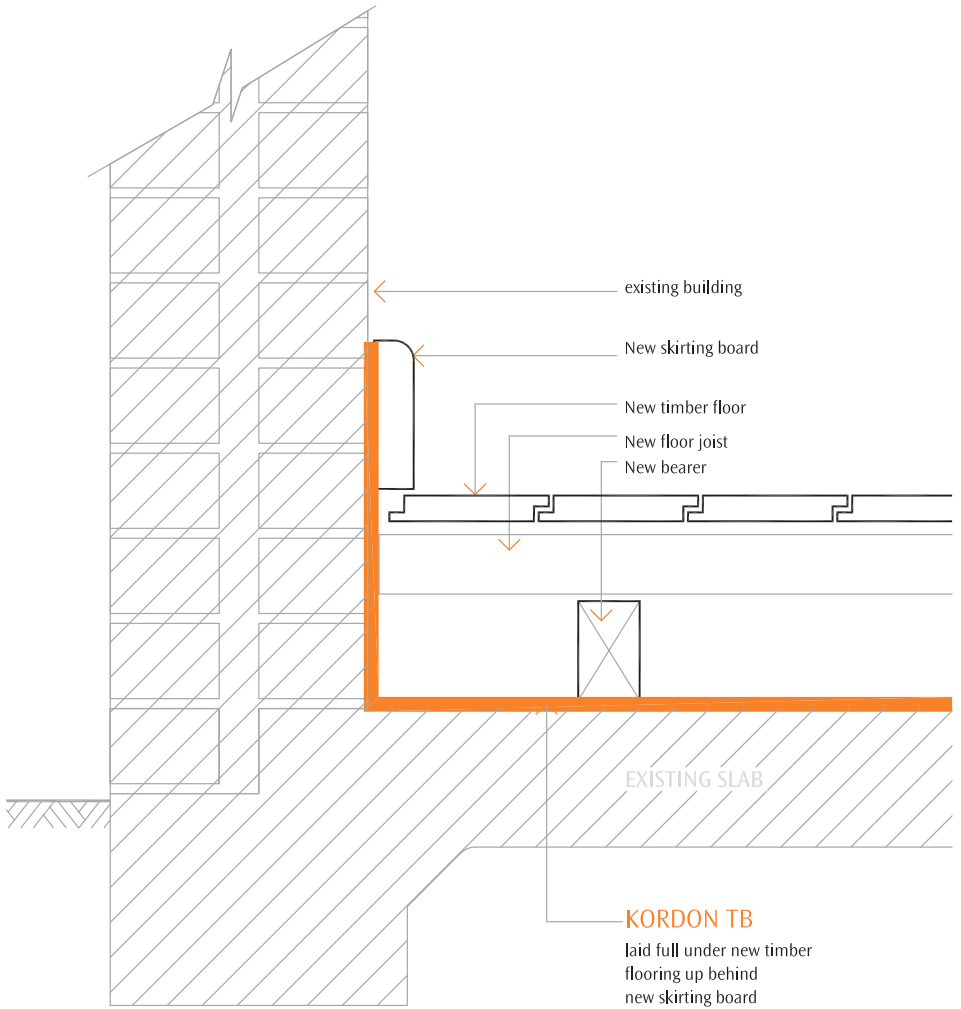


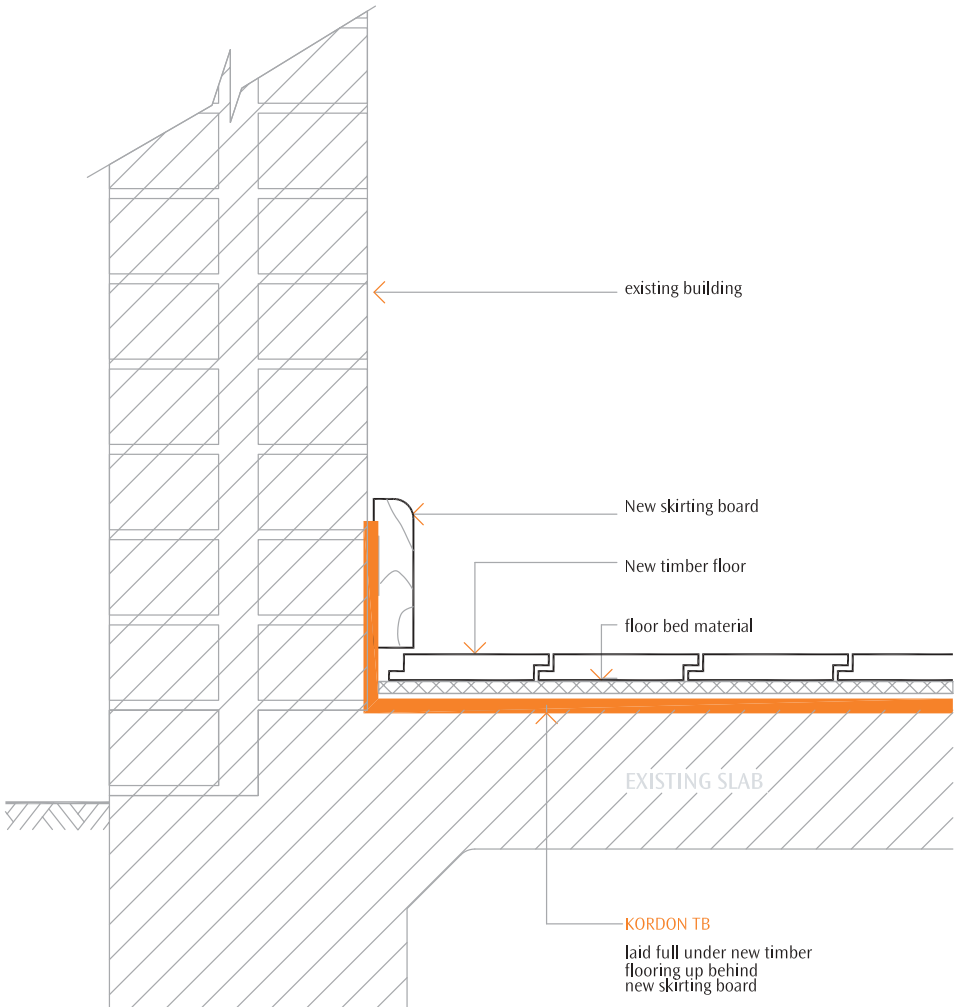




Note:

before any new work commences it is a condition of Australian building standards to have completed a termite inspection of the existing structure.





existing building

New skirting board

New timber floor

floor bed material

EXISTING SLAB

**KORDON TB**

laid full under new timber flooring up behind new skirting board

the use of an adhesive spray is recommended to assist in securing the Kordon TB installation

a minimum of 50mm overlap is required at Kordon TB joints

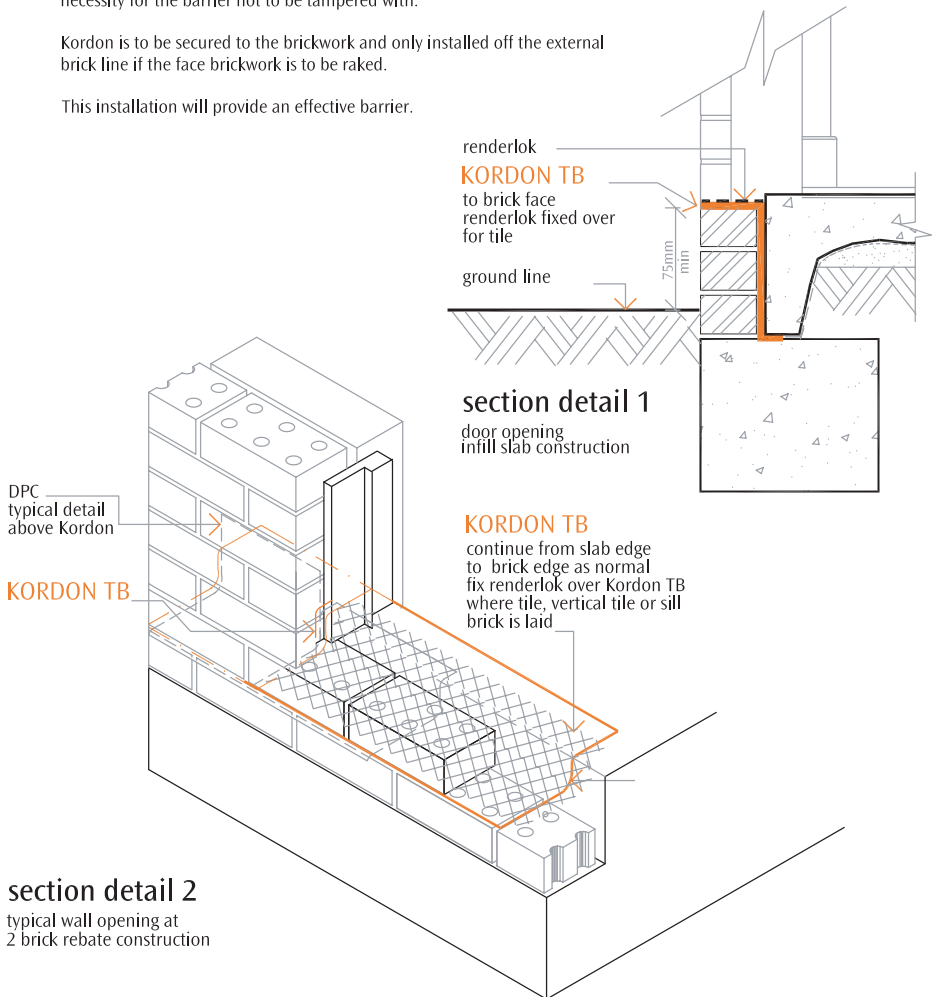
Kordon installed to brickwork, where a sill tile/brick/half brick is secured on top of Kordon.

These tiles etc may move, or be displaced, in particular when the vertical face of the sill is minimal, thus not allowing much room for the sand and cement bed to be placed before installing the sill tile.

The superseded installation detail kd052 will "deter concealed termite access" however it appears that in some cases, the detail is being misinterpreted, with the product in some instances being removed completely off the sill, which is not acceptable. The tilers / bricklayers have to be aware of the necessity for the barrier not to be tampered with.

Kordon is to be secured to the brickwork and only installed off the external brick line if the face brickwork is to be raked.

This installation will provide an effective barrier.





incorrect Kordon TB installation. Refer kd 001 and product design principle

1.



4.

if tiling is to extend to slab edge Kordon TB is installed as shown - secured with gal hoop-iron/strapping.



2.

5.

renderlok secured to masonry with approved concrete nails. - (15mm length preferred)



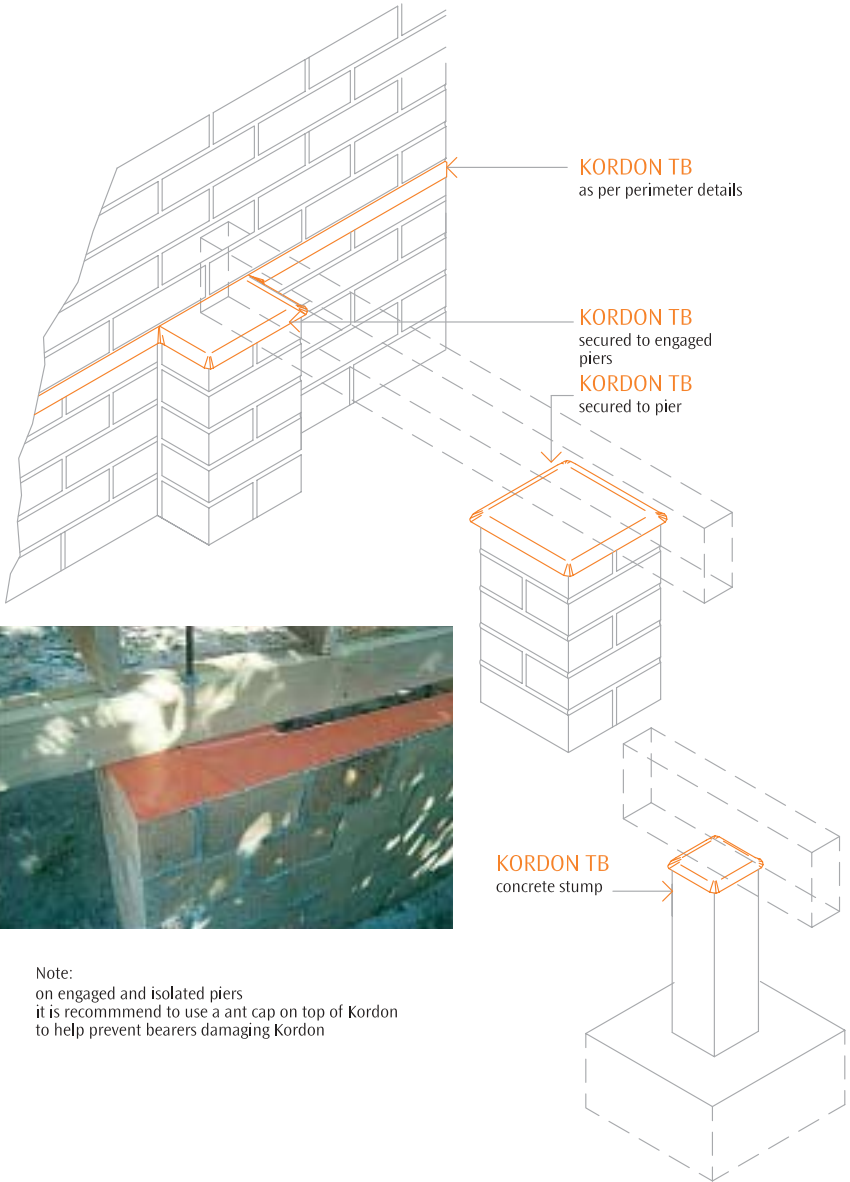
3.

close up of 5.

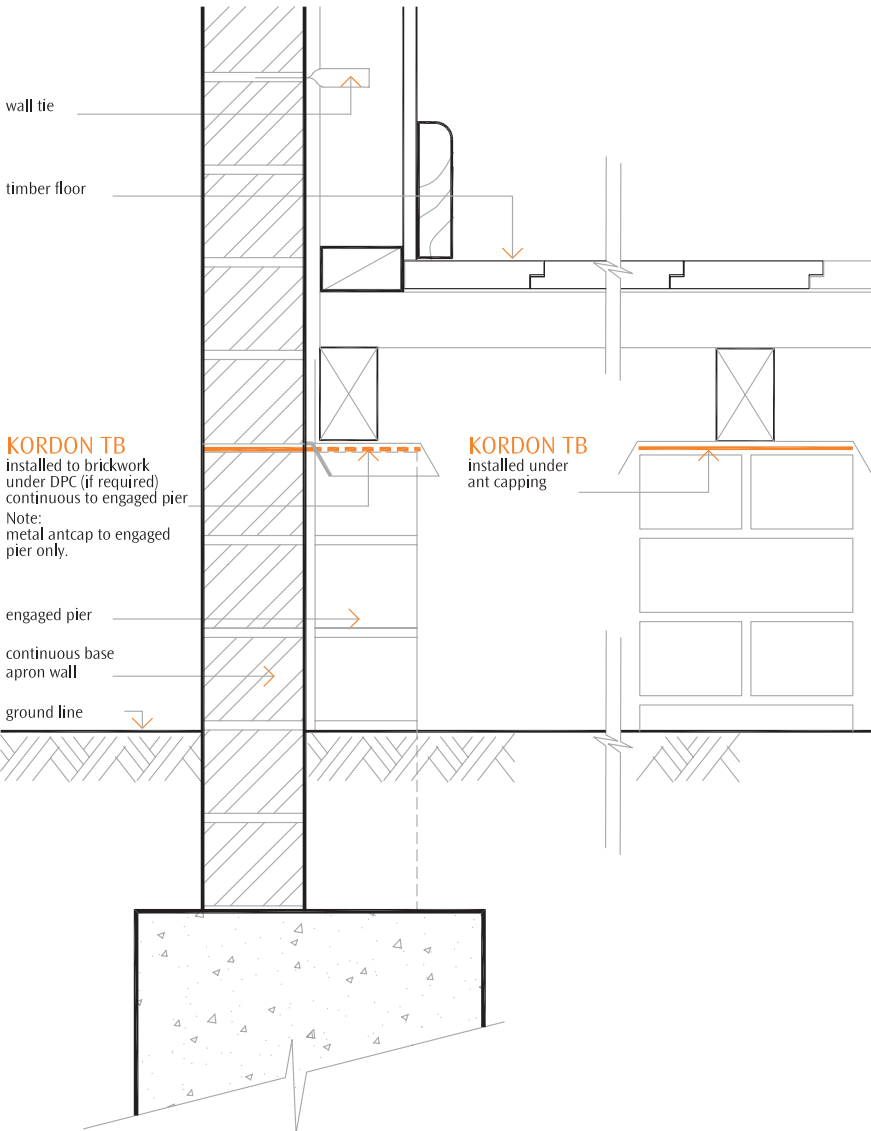


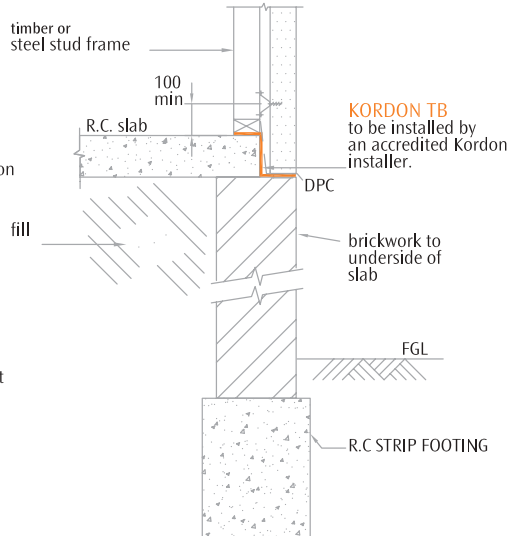
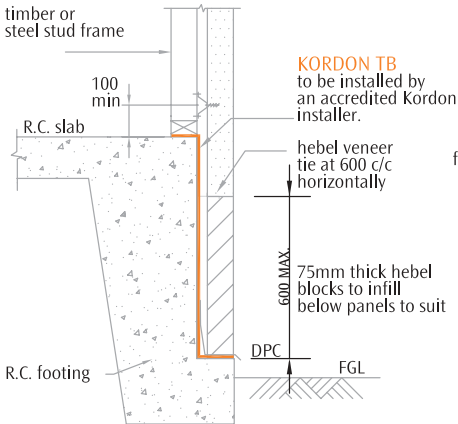
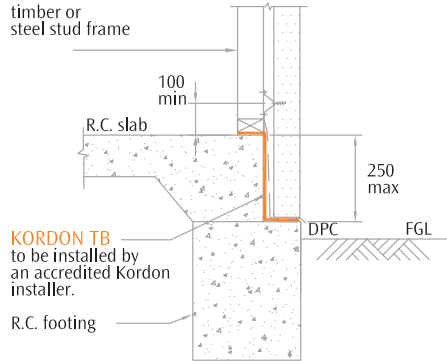
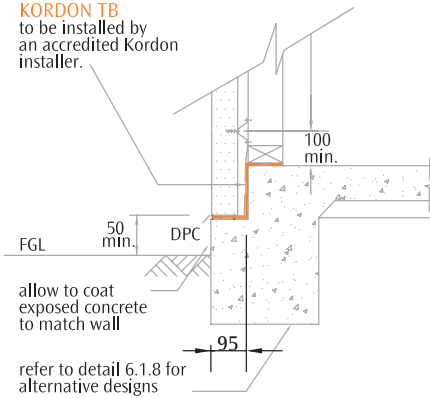
6.

renderlok secured to horizontal & vertical to accommodate tiling specification

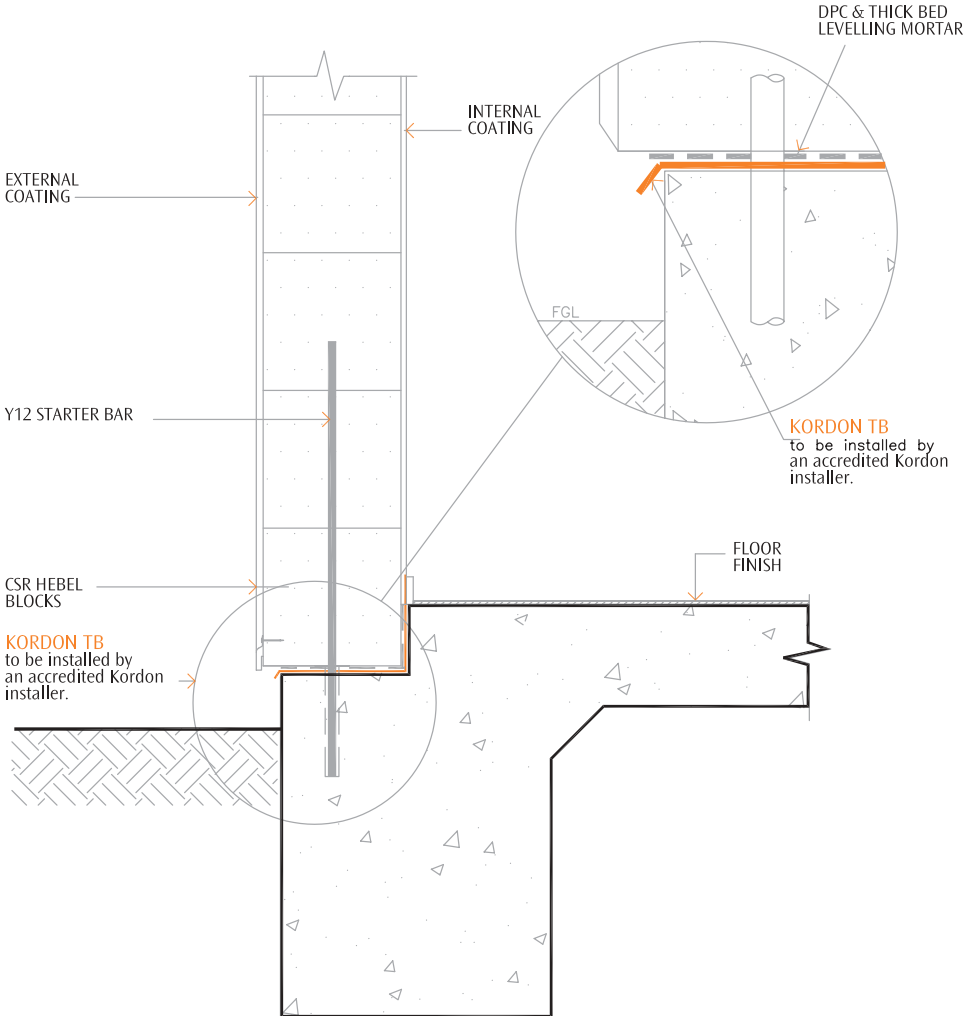


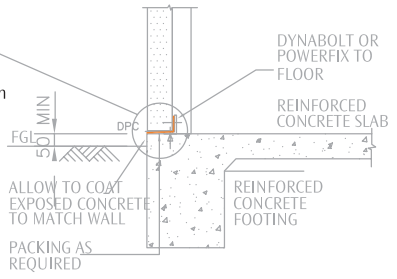
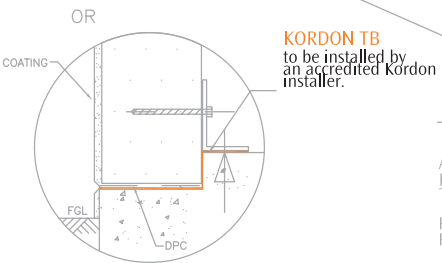
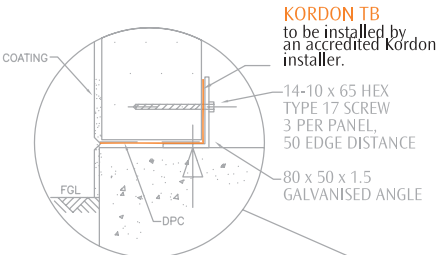
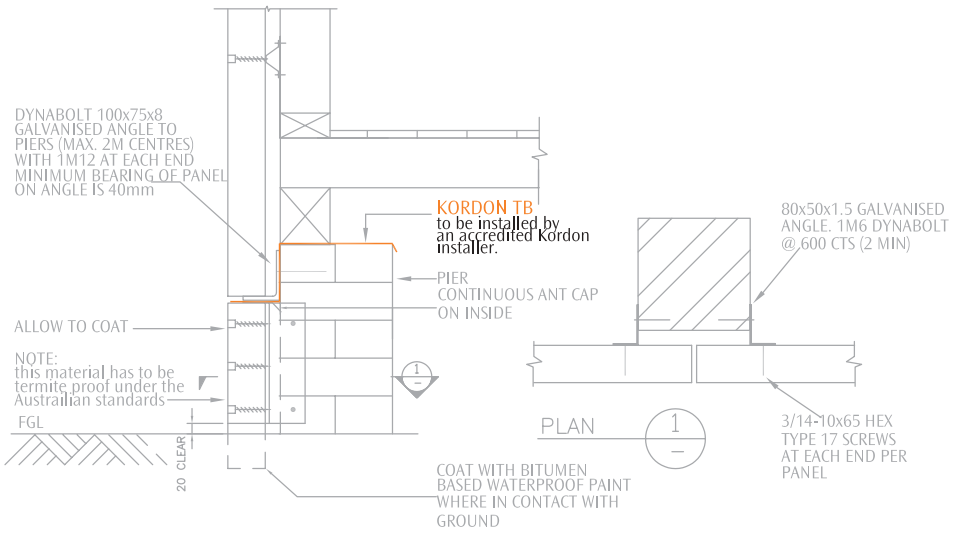
Note:  
on engaged and isolated piers  
it is recommend to use a ant cap on top of Kordon  
to help prevent bearers damaging Kordon

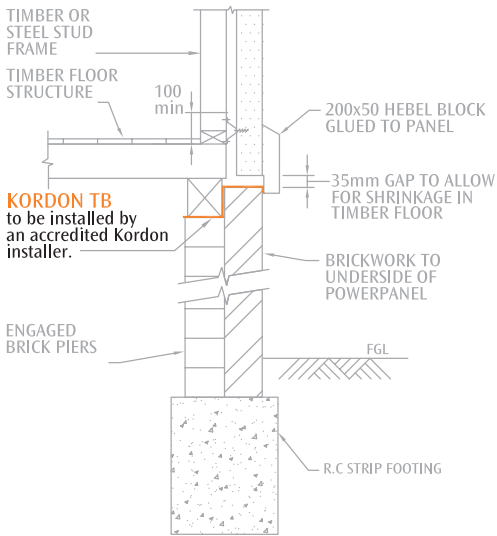
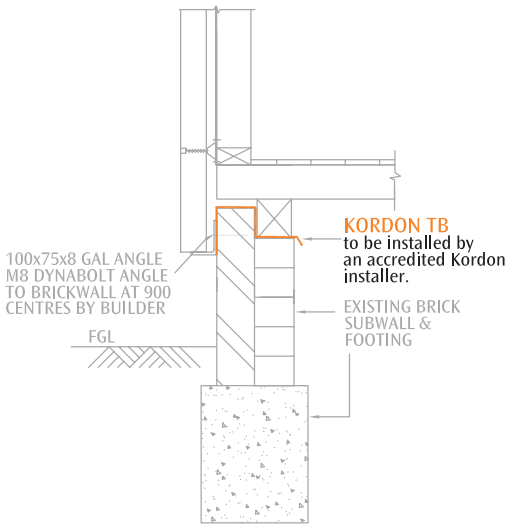
















## Kordon Major Project list

The following projects and builders have selected Kordon Termite Barrier as their termite management system.

Laverick Army Barracks  
– Townsville – QLD

**Builder – Theiss Constructions**

Adelaide Wine Centre – SA

**Builder – Hansen & Yuncken**

Kempsey Correctional Centre – NSW

**Builder – Holland & Leahy  
Construction**

Aldi Distribution Centre  
– Minchinbury – NSW

**Builder – Walter Construction**

Yeronga TAFE College – QLD

**Builder – Boulderstone Hornibrook**

Wollongong Hospital  
(Extension) – NSW

**Builder – John Holland**

Croydon 24 hour Police Station – VIC

**Builder – ADCO Constructions**

DNRE Building – Bendigo – VIC

**Builder – Kane Construction**

Maryborough Hospital  
(Extension) – VIC

**Builder – Kane Construction**

Ansto Nuclear Plant – Lucas  
Heights – NSW

**Builder – Holland Constructions**

Coomera P12 Public School

**Builder – Walter Construction**

Prince Alfred Hospital Brisbane – QLD

**Builder – AW Edwards**

Southport School Science Block

**Builder – DCA Project Services Aust**

Defence Housing – ACT

**Builder – Defence Housing**

South Australian Housing Trust – SA

**Builder – South Australian  
Housing Trust**

Landsvale Public School – NSW

**Builder – Dept of Public Works**

Qantas Flight Training Centre – VIC

**Builder – Leighton Construction**

Ipswich Grammar School – QLD

**Builder – Glenlea Building Projects**

CSIRO Complex – Gatton – QLD

**Builder – Vic Salomon  
Constructions**

St Catherine's School Sports  
Centre – Randwick – NSW

**Builder – Infinity Constructions**

University of Western Sydney – NSW

**Builder – St Hillier's**





## Certificate of Compliance

This document is to certify that the Kordon TMB / TB system was installed by a Bayer Accredited Installer and has been completed in accordance with the Manufacturer's specifications. Kordon TMB / TB complies with AS 3660.1 - 2000, the primary referenced standard of the Building Code of Australia. Kordon TB is only part of a termite management system for a new property. The slab must be constructed in accordance with the Standard; Residential Slabs and Footings Construction, AS 2870-1996

NOTE: This is to be attached to Warranty Document Number: warrantyNumber

Installation address1 Installation Date: 10/03/2004  
Address: address2  
address3  
address4  
Builder: buildername Phone Number: 0344445555  
Owner: ownername Phone Number: 0399998888  
Local Council: councilname Phone Number: 0377776666

Job Type: jobtypedesc  
Total square metres installed: 10  
Number of service penetrations protected: 5  
Product punctures repaired where/if necessary: Yes

Company Contact: companycontact Accreditation Number: Admin  
Installer's Name: installersname Phone Number: WorkPhone  
Company Name: companyname Fax Number: faxnumber  
Address: address  
City  
StateOrProvince Post Code: PostalCode  
Authorised Signature: \_\_\_\_\_ Date: 10/3/2004

Comments: CertificateComments



# Warranty

This warranty is granted by Bayer Environmental Science ("Bayer") (ACN 000 226 022) of 391-393 Tooronga Road East Hawthorn Victoria in respect of the installation of Kordon Termite Barrier ("Kordon") in the Building.

Warranty No. warrantyNumber

This Warranty covers damage by Subterranean Termites ("Termites") only. Bayer warrants that Kordon shall restrict the entry of Termites into the Building through the Kordon barrier for a period of ten (10) years from the date of installation ("Warranty Period").

This Warranty covers damage by Termites to structural timbers and internal timbers BUT DOES NOT INCLUDE damage by Termites to:

- (a) chattels of any nature whatsoever including (but without limiting the foregoing) antiques, heirlooms, paintings, artwork; and
- (b) any pergolas, wiring, extensions to the Building and outhouses.

If Termite infestation of the Building occurs as a result of the failure of the Kordon and damage by Termites is caused to structural timbers and/or internal timbers fixtures and fittings during the Warranty Period, Bayer will without charge to the Owner:

- (a) repair the Kordon barrier where practicable;
- (b) cause the repair or replacement of structural timbers and/or internal timbers so damaged.

To the extent permitted by the Law of the State or Territory in which the premises are located:

- (a) the liability of Bayer under this Warranty is limited to a maximum of \$100,000.00 in respect of any one (1) warranty claim.
- (b) All representations and other warranties express or implied and whether arising by virtue of Statute or otherwise are excluded or limited as stated in this Warranty.

This Warranty shall only have effect if the Kordon is installed by a Bayer Accredited Installer.

#### OWNER'S RESPONSIBILITIES

The Owner of the Building during the Warranty Period ("Owner"), at the Owner's expense, arrange for thorough and regular inspection of the Building for the presence of termites at intervals not exceeding 12 months by an accredited/licenced Timber Pest Inspector.

Where the Termite risk is high (e.g. North of the 26th parallel) more frequent inspections (3-6 months) should be undertaken.

These inspection recommendations comply with those outlined in AS 3660 Termite Management Series and AS 4349.1-1995, Inspection of buildings. If Termites are detected or are found to have breached the Kordon barrier, the Owner must, within 7 days of such detection, notify Bayer.

#### EXCLUSIONS

This Warranty shall be void and have no effect in any of the following circumstances:

The Kordon barrier is damaged, modified, bridged or otherwise interfered with by any person or any act, fact, matter or thing beyond the reasonable control of Bayer. The Building is structurally modified, altered or otherwise changed in any way which would or may diminish the effectiveness of the Kordon as a Termite barrier. If at any time during the Warranty Period, the Owner

- (a) allows or fails to prevent accumulation of:
  - (i) wood, rubbish or timber against the Building; AND
  - (ii) finished ground level around the Building to a height which does not comply with the terms of the Installation Manual.
- (b) allows the barrier dividing the soil surface and the structure of the Building formed by the Kordon to be bridged or broken by any other material or matter through which Termites may by-pass the Kordon and infest the Building.

Termites shall enter the Building through any manner other than by a breach of the Kordon barrier. If the Kordon is installed other than by an Bayer Accredited Installer.



BUILDING: address1  
address2, address3, address4

DATE OF INSTALLATION: 10/03/2004

BAYER ACCREDITED INSTALLER: installersname  
companyname  
address, City, StateOrProvince, PostalCode

CONTACT NUMBER: WorkPhone

ACCREDITATION No: Admin

THIS WARRANTY SHALL BE VOID UNLESS THE KORDON HAS BEEN INSTALLED BY A BAYER ACCREDITED INSTALLER.

Bayer will grant additional specific warranty conditions where required to accommodate high density, commercial constructions, government buildings, etc on documented request.





 **KORDON**<sup>®</sup>  
**TERMITE BARRIER**

**Ph. 1800 634 913** [www.kordontmb.com.au](http://www.kordontmb.com.au)

Bayer Environmental Science 391-393 Tooronga Road Hawthorn East, Vic. 3123 ABN 87 000 226 022

Designed and manufactured in Australia. Kordon<sup>®</sup> is a Registered Trademark of Bayer.

Bayer Environmental Science is a business group of Bayer Cropsience Pty Ltd.

BEK0004/The Hopkins Part.



Bayer Environmental Science